

User manual

SOMA 100 Series

(SM-100.5 and SM-150.5)



GENERAL WARNING

- DO maintain your chair well, in particular check the tyre (tire) pressure since this affects the efficiency of the brakes.
- DO make sure both brakes are applied before getting in or out of the chair.
- DO make sure both brakes are applied when the chair is not being pushed or used.
- DO take care when climbing curbs or turning on slopes.
- DO avoid steep or uneven surfaces that may cause the chair to tip over.
- DO avoid soft surfaces because the casters may become bogged down.
- DO travel smoothly in all conditions.
- DO look well ahead to anticipate hazards such as furniture, doors, potholes, etc.
- DO make sure that both feet are safely on the footrests and that clothing is safely tucked out of the way so that it cannot get caught in the wheels.
- DO take care when traveling up or down or across inclines.
- DO keep both hands on the push handles to control the chair, if you are the attendant.
- DO pay attention to keep the chair balanced.
- DO check the frame and components regularly and refer to this user guide during and after the warranty period.
- DO tie-up the upholstery or replace it with a new one when it becomes loose.
- DO lubricate bearings regularly.
- DO equip with anti-tippers to avoid falling backwards.
- DO equip with a seat belt designed for disabled people.
- DO equip with "ankle supports" for disabled people.
- DO clean both hands after oiling the wheelchair.
- DO NOT overload the chair in any circumstance.
- DO NOT hang anything heavy on the back of the chair that could cause the chair to become unstable, particularly when negotiating inclines.
- DO NOT allow more than one user at a time.

- DO NOT allow any unconscious patient to use the wheelchair.
- DO NOT use other transport to pull the wheelchair.
- DO NOT do "wheelies", since you may fall or tip over backwards and suffer a severe injury.
- DO NOT sit in the wheelchair within a moving vehicle unless it has been affixed the labels of hook mark.
- DO NOT go too fast or turn too quickly.
- DO NOT stand on the footplates when getting in or out of the chair.
- DO NOT go down steps forward, whether solo or with an attendant.
- DO NOT attempt to lift the wheelchair by any removable (detachable) parts. Lifting by means of any removable (detachable) parts of the wheelchair may result in injury to the user and/or assistant or damage to the wheelchair.
- DO NOT use the wheelchair when back joint folded to against tipping over backwards. It is only for folding and storage purpose.
- DO NOT hang anything on the back joint that could cause the backrest folding suddenly and may cause injury.

YOU AND YOUR KARMA SERVICE PROVIDER

- No tools are required for assembly. Your wheelchair should be assembled by your authorized KARMA dealer. Your authorized KARMA dealer is also your service provider. Unauthorized repairs, upgrades and add-ons will void your warranty. Anything wheelchair related that requires tools should be done by your authorized KARMA service provider. Your KARMA service provider has the necessary service/maintenance manual for your wheelchair.
- If you have any defective parts or lose any parts, please contact your dealer for repair and/or replacement. Please only use parts authorized by KARMA. Use of parts that are not authorized by KARMA will void your warranty.
- Part numbers are listed on our bill of materials (explosion drawings), which we give to our authorized dealers and service providers. Customers should order parts through their dealer as well as all repairs and scheduled maintenance.

- Customers should go to their dealership for all service needs to guarantee their warranty is not void. Always go to an authorized service provider. Unauthorized repairs will void your warranty. Procedures other than those described in this owner's manual must be performed by a qualified technician. They also have the service manual with a complete list of maintenance required to keep your KARMA wheelchair in top performance. Check the warranty section of this owner's manual to find out what KARMA guarantees and what maintenance service and parts that are not covered by the warranty.
- KARMA does not have an official list of service providers at this time. Please contact your dealer for service. If you cannot contact your dealer, please contact another authorized KARMA dealer for service. If all else fails, contact KARMA directly via our website or give us a call and we can refer you to your new service provider.

CE MARKING

- This wheelchair complies with the requirements of the Medical Devices Directive 93/42/EEC.



CAUTION:

- When prescribing wheelchairs for use by full or partial amputees (above or below knee, single or double) or other conditions that affects the user's natural center of gravity and might cause the wheelchair to tip or the person on the wheelchair to fall off, we suggest contacting your therapist or dealer as well as attaching anti-tippers, pelvic belt, or other additional safety accessories.
- When using the wheelchair, **ALWAYS** follow the Highway Code or your local traffic regulations when outdoors and the guidelines written in this manual.

TABLE OF CONTENTS

1. PREFACE.....	1
2. SAFETY	2
2.1 DOORWAYS.....	2
2.2 LEANING	2
2.3 NEGOTIATING INCLINES	2
2.4 KERB(CURBS)	2
2.5 STAIRS	3
2.6 STREETS.....	3
2.7 GENERAL.....	3
2.8 UPHOLSTERY	4
2.9 ANTI-TIPPERS.....	4
2.10 MAXIMUM USER WEIGHT LIMIT	4
2.11 AVOID GENERAL MISUSE.....	4
2.12 LABELING.....	5
3. INTENDED USE & PARTS	6
3.1 INTENDED USE.....	6
3.2 PARTS DESCRIPTION (SM-100.5 SERIES WITH 22").....	6
3.3 PARTS DESCRIPTION (SM-100.5 SERIES WITH 16").....	7
4. OPERATION.....	8
4.1 UNFOLDING	8
4.2 FOLDING	8
4.3 IMPORTANT DOs AND DON'Ts	9
4.4 FOOTPLATE HEIGHT	9
4.5 HOW TO USE THE TIPPING LEVER.....	10
4.6 FOOTREST INSTALLATION AND ADJUSTMENT	10
4.7 TRANSPORTING AND STORING.....	10
4.8 TRANSFERRING IN	11
4.9 TRANSFERRING OUT	11
4.10 ATTENDANT PUSHING AND SELF-PROPELLED	12

4.11 TILTING BY THE ATTENDANT	14
4.12 TILTING BY THE USER.....	14
4.13 GOING DOWN CURBS	14
4.14 GOING DOWN CURBS FORWARDS WITH AN ATTENDANT	15
4.15 GOING DOWN CURBS BACKWARDS WITH AN ATTENDANT	15
4.16 GOING UP CURBS	15
4.17 GOING UP CURBS FORWARDS WITH AN ATTENDANT	16
4.18 GOING UP CURBS BACKWARDS WITH AN ATTENDANT.....	16
4.19 UP AND DOWN STEPS/STAIRS.....	16
5. INSPECTION AND MAINTENANCE.....	17
5.1 DAILY CHECK.....	17
5.2 REGULAR MAINTENANCE RECORD	17
6. OPTIONA AND ACCESSARIES	19
7. TROUBLESHOOTING	20
8. SPECIFICATIONS	21
9. CLEANING & RECYCLING.....	24
9.1 CLEANING.....	24
9.2 FRAME.....	24
9.3 UPHOLSTERY	24
9.4 POST-CONSUMER RECYCLING	24
10. WARRANTY.....	25
10.1 SERIAL NUMBER.....	25
10.2 CONTENTS AND DURATION OF WARRANTY	25
10.3 THE CLAIMS FROM THIS WARRANTY SHALL NOT ARISE FOR THE FOLLOWING REASONS	25
10.4 KARMA IS NOT RESPONSIBLE FOR THE FOLLOWING COSTS.....	26
10.5 THE RESPONSIBILITIES OF THE USER.....	26
10.6 THE RESPONSIBILITIES OF THE DEALER.....	26
10.7 TRANSFER OF WARRANTY RIGHTS	27



1. PREFACE

Please carefully read this owner's manual before using the wheelchair. Improper use of the wheelchair could result in harm or injury. Therefore, for safe and enjoyable use of the wheelchair, please read this owner's manual.

1.1 This owner's manual includes operation instructions for the aspects of the wheelchair, unfolding/folding instructions and instructions on how to deal with possible accidents.

1.2 This owner's manual is written for KARMA wheelchair: SM-100.5 series.

1.3 The symbols used in this owner's manual are explained below. Pay special attention to the parts marked with these symbols.

 WARNING:	Improper use could lead the user to severe injury or death.
 CAUTION:	Improper use could lead the user to severe injury and/or damage to your wheelchair.
 SUGGESTION:	Follow these instructions to keep the wheelchair in good condition.

1.4 This owner's manual includes the repair and maintenance chart as well as the warranty.

1.5 If someone else uses the wheelchair, make sure that you give him or her this owner's manual for his or her reference.

1.6 As designs change, some illustrations and pictures in this owner's manual may not correspond to the wheelchair that you purchased. We reserve the right to make design modifications without further notice.

2. SAFETY

2.1 Doorways

The safest way to operate the chair is on level floors that are free of obstacles. Whenever possible use a ramp to enter or exit a facility. Keeping your hands on the push rims will allow you to maintain maximum balance. Do not try to force yourself over an obstruction by propulsion and never use the sides of a doorway to pull yourself through a passageway.

2.2 Leaning

Do not lean over the side of your wheelchair since such an action may cause you to lose balance and fall. (See Figure 2.1)



Figure 2.1



Figure 2.2



Figure 2.3

2.3 Negotiating Inclines

- 2.3.1 Never turn on a hill due to the danger of tipping.
- 2.3.2 When assisting, go straight up a slope. If user needs to go down midway, walk backwards until user is on level ground. (See Figures 2.2 and 2.3)
- 2.3.3 Avoid stopping on an incline; it can potentially cause you to lose control of the chair.
- 2.3.4 Do not use the brakes to slow down or stop the wheelchair; this could cause it to seize up, causing you to lose control or fall out of the chair.
- 2.3.5 Whenever possible, utilize help from an assistant/attendant while negotiating inclines.

2.4 Kerb(Curbs)

- 2.4.1 Whenever possible get help from an assistant/attendant (if you have assistance make sure that your chair is equipped with push handles).
- 2.4.2 Avoid hard impacts when descending a curb. A hard impact could adversely affect the chair.
- 2.4.3 Never try to scale or descend curbs that exceed a normal height (30-50mm).

2.4.4 Always be careful when climbing curbs and never move up or down a curb in reverse without an assistant.

2.5 Stairs

2.5.1 Always use two or more assistants. Tilt the wheelchair to its point of equilibrium. One assistant (at the back) holds the wheelchair up against the first step, gripping the handles firmly to lift. The second assistant, holding firmly a fixed part of the front frame, lifts the wheelchair above the stairs and holds it while the first attendant places one foot on the following step and repeat the operation. (See Figure 2.4)

2.5.2 Never go down steps forwards.

2.5.3 Never use an escalator for transport, use an elevator.



Figure 2.4



Figure 2.5

2.6 Streets

2.6.1 Always use extreme caution when crossing streets. Reflective tape on the chair and/or your clothing will make you more visible to drivers.

2.6.2 Avoid potholes and rough terrain that might cause the casters to become stuck. (See Figure 2.5)

2.7 General

2.7.1 The expected service life of the product is **5 years**, presuming that the product is used daily in accordance with the safety operation instructions, inspection and maintenance instructions, and intended use, which described in this manual.

2.7.2 Always make sure BOTH brakes are applied before getting in or out of the chair.

2.7.3 Never stand on the footplates when getting in or out of the chair.

2.7.4 Never carry more than one passenger. KARMA wheelchairs are limited to one user.

2.7.5 Use caution to assure your clothing doesn't get tangled with the wheels.

2.7.6 When the user is operating the wheelchair using the pushrims, please push the wheelchair gently. DO NOT apply a sudden huge force on the pushrims. It could

cause the chair to tip over. Please refer to the figure below for the best grip points for using the pushrims.

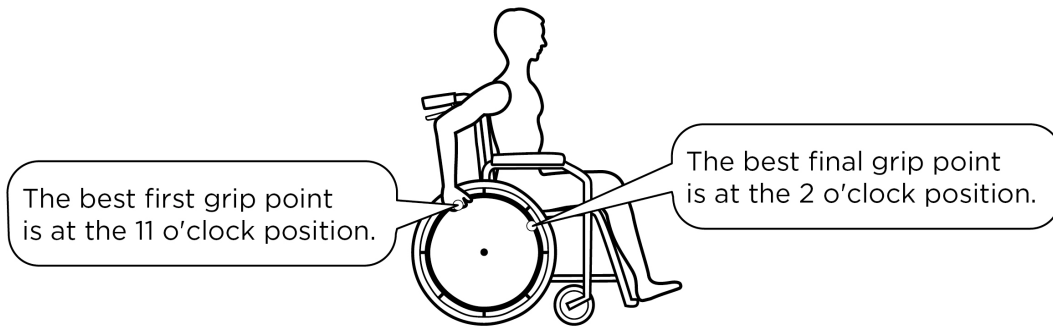

2.8 Upholstery

2.8.1 When cleaning the upholstery, use warm water and a mild soap.

2.8.2 Upholstery cleaner/foam can also be used, but avoid other cleaning solvents.

2.9 Anti-tippers

Please purchase anti-tippers and always use them to avoid personal injury. The distance between anti-tipper and wheels is more than 5cm; the height to floor doesn't be over 5cm. (See Figure 2.6)

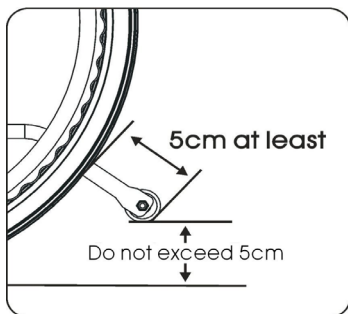

Figure 2.6



Figure 2.7

2.10 Maximum User Weight Limit

Refer to "Max. User Weight" in Section 8. SPECIFICATIONS. Loads exceeding maximum capacity can damage your wheelchair and cause malfunctions yielding a safety hazard. The warranty does not cover damage caused by improper operation of the wheelchair.

2.11 Avoid General Misuse

2.11.1 Please note that our "Owner's Manual" contains a number of cautions -- any vehicle can cause injury if misused -- use within our guidelines and with reasonable care and your safety will be increased. Your wheelchair will give years of safe use if used sensibly and carefully. Be aware that careless use endangers

your own safety as well as that of others. ALWAYS follow the Highway Code when outdoors and the guidelines written in this owner's manual.

2.11.2 Do not let children stand or play on the wheelchair. (See Figure 2.7)

2.12 Labeling

Please carefully read all the labeling on the wheelchair before driving it. Do not remove them. Protect them for future reference.



1

EC REP	KARMA MOBILITY, S. L. C/ PERIODISTA FRANCISCO CARANTONA DUBERT, 23 Bajo 33209 GIJÓN - ASTURIAS (SPAIN)	CE
UK REP	KARMA MOBILITY LTD. UNIT 6 TARGET PARK, SHAWBANK ROAD, REDDITCH, B98 8YN ENGLAND UNITED KINGDOM	UK CA
	KARMA MEDICAL PRODUCTS CO., LTD. NO. 2363, SEC. 2, UNIVERSITY RD., MIN-HSIUNG SHIANG, CHIA-YI HSIEN, TAIWAN R.O.C.	MD
WARNING! USE ONLY ON STABLE SURFACES MAXIMUM USER WEIGHT 100kg (220 lbs)		

2

SERIAL NO. HM15-004155

Model:	
Order No.:	
Delivery Date:	
Sewing No.: 1 <input type="checkbox"/> 2 <input type="checkbox"/> 3 <input type="checkbox"/> 4 <input type="checkbox"/> 5 <input type="checkbox"/> 6 <input type="checkbox"/>	
Seat Width	Seat Depth
<input type="checkbox"/> 13 <input type="checkbox"/> 14 <input type="checkbox"/> 15 <input type="checkbox"/> 16 <input type="checkbox"/> 17 <input type="checkbox"/> 0 <input type="checkbox"/> 18 <input type="checkbox"/> 5 <input type="checkbox"/> 19 <input type="checkbox"/> 20 <input type="checkbox"/> 21 <input type="checkbox"/> 22 <input type="checkbox"/> _____	<input type="checkbox"/> 13 <input type="checkbox"/> 14 <input type="checkbox"/> 15 <input type="checkbox"/> 16 <input type="checkbox"/> 17 <input type="checkbox"/> 0 <input type="checkbox"/> 18 <input type="checkbox"/> 5 <input type="checkbox"/> 19 <input type="checkbox"/> 20 <input type="checkbox"/> 21 <input type="checkbox"/> _____
karma	
Unit: inch	

105-90039 Rev.02

3. INTENDED USE & PARTS

3.1 Intended Use

3.1.1 The SM-100 .5Series is a self-propelled or transit wheelchair. That is, it can either be propelled by an attendant (transit) or by the user (self-propelled).

3.1.2 These wheelchairs are suitable for users up to 100 kg in weight. Hand brakes are provided for both rear wheels.

3.1.3 The casters have PU tyres tires for greater durability.

3.1.4 Rear wheels are 22 inches in diameter and solid PU tyres (tires).

3.1.5 SM-100.5 series are equipped with 16" rear wheels.

3.2 Parts Description (SM-100.5 Series With 22")

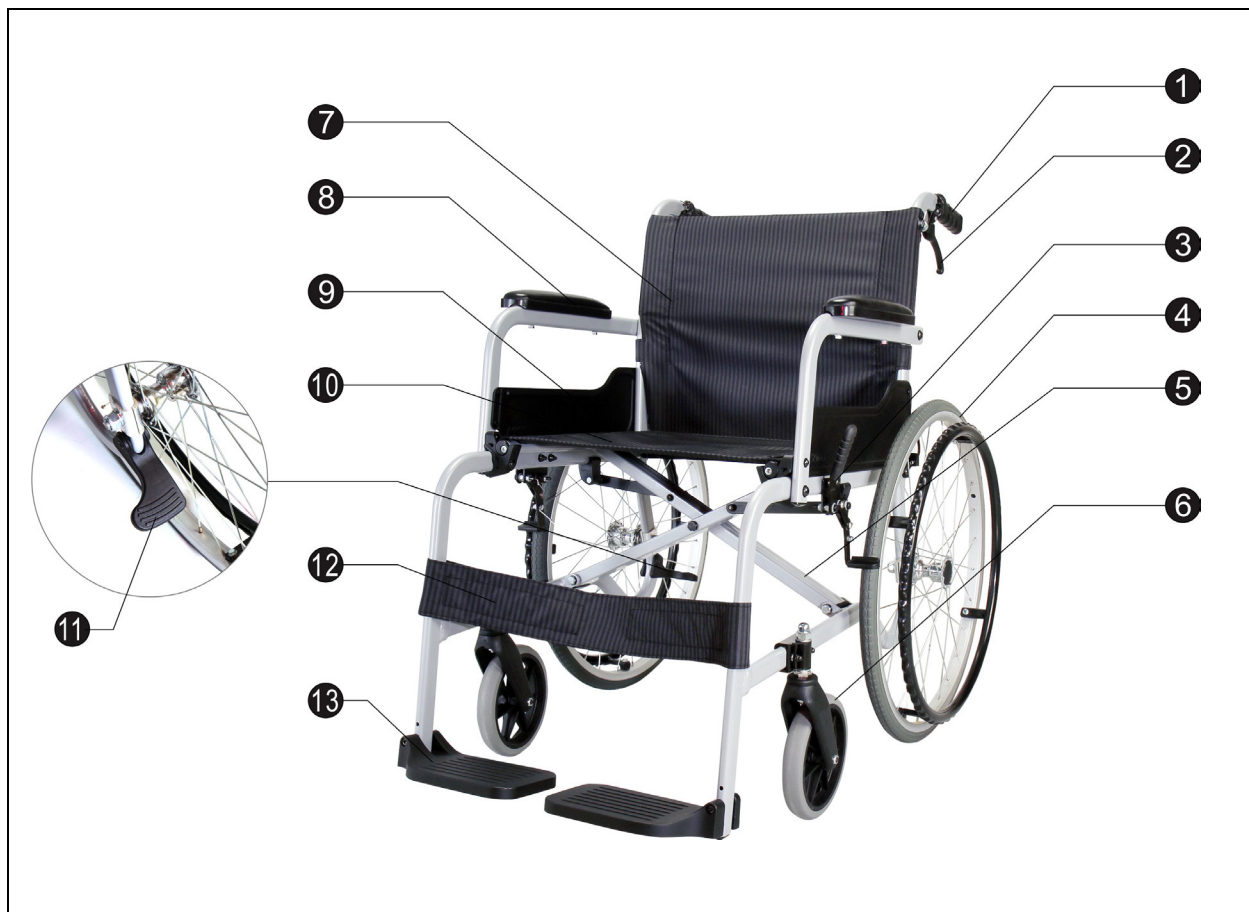

1. Push Handle	8. Armrest
2. Attendant Brake	9. Side Panel
3. Parking Brake	10. Seat Upholstery
4. Rear Wheel	11. Tipping Lever
5. Cross Frame(Cross Bar)	12. Calf Strap
6. Caster	13. Footplate
7. Backrest Upholstery	

3.3 Parts Description (SM-100.5 Series With 16")

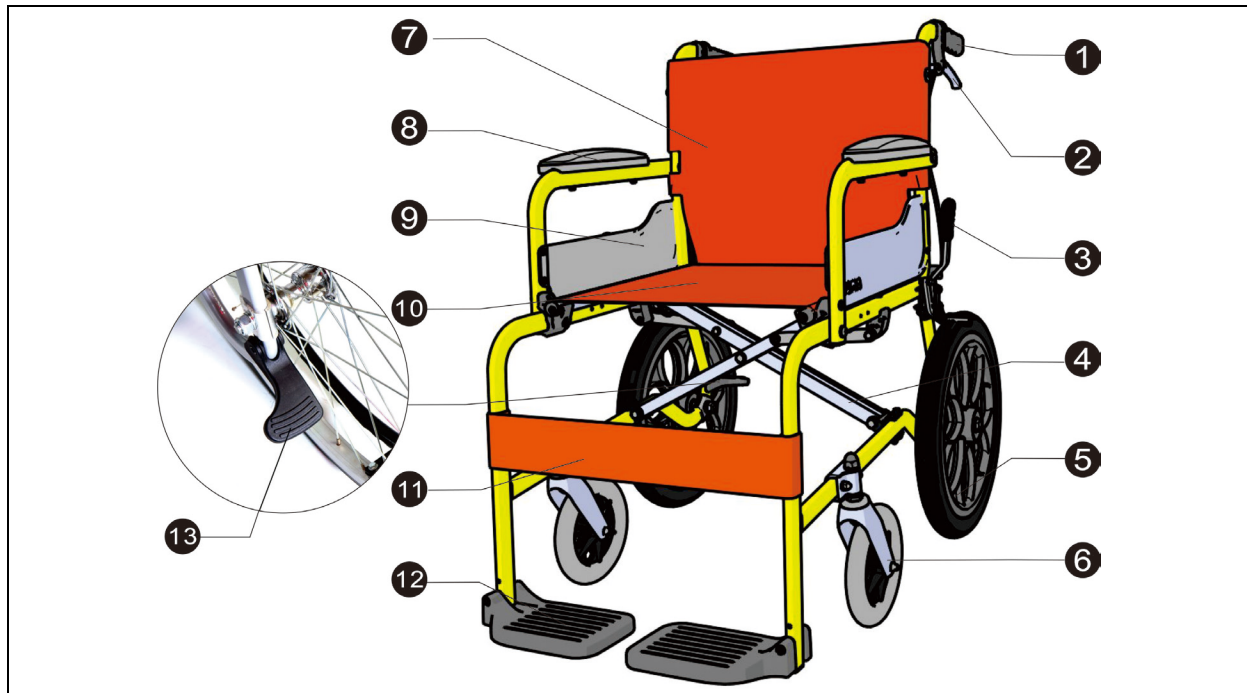

- | | |
|---------------------------|---------------------|
| 1. Push Handle | 8. Armrest |
| 2. Attendant Brake | 9. Side Panel |
| 3. Parking Brake | 10. Seat Upholstery |
| 4. Cross Frame(Cross Bar) | 11. Calf Strap |
| 5. Rear Wheel | 12. Footplate |
| 6. Caster | 13. Tipping Lever |
| 7. Backrest Upholstery | |

4. OPERATION

4.1 Unfolding

4.1.1 Unfold the push handle. (See Figure 4.1) (for SM-150.5)

4.1.2 Holding the armrests, pull outwards. (See Figure 4.2)

4.1.3 Pointing your fingers inward with the palm of your hand on the frame, push down until the seat is fully lowered. Make sure the frame is firmly seated in its holder. (See Figure 4.3)

4.1.4 Swing the footplates down. (See Figure 4.4)

4.1.5 Ready for action!

Alternatively, you can stand at the side of the chair and complete step 1 by pulling the nearest armrest towards you and pushing the other one away.



Figure 4.1



Figure 4.2



Figure 4.3



Figure 4.4



CAUTION:

- When completing step 2, never put your fingers around the sides or under the chair as they can be trapped between the seat and the frame. (See Figure 4.5)

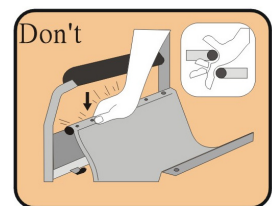

Figure 4.5

4.2 Folding

4.2.1 Flip up the footplates. (See Figure 4.6)

4.2.2 Pull up on the seat upholstery by holding it in the center of its front and back edge. (See Figure 4.7)

4.2.3 Press the two release levers on the backrest frame (push handle tubes) to fold the backrest down for compact storage and easy transport (for SM-150.5). (See Figure 4.8)

4.2.4 Folding is now completed.



Figure 4.6



Figure 4.7

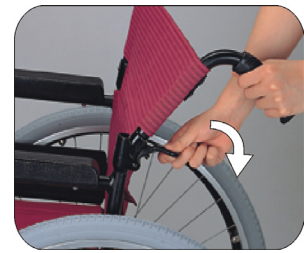

Figure 4.8

 **CAUTION:**

- Be careful not to get your fingers caught when folding the wheelchair.

4.3 Important DOs and DON'Ts

4.3.1 DO: Keep axles clean and lubricated with light oil or maintenance spray.

4.3.2 DO: Maintain correct tyre (tire) pressure if using pneumatic tyres (tires).

4.3.3 DO NOT: Try to remove the wheels while the wheelchair is occupied even when using anti-tippers.

4.4 Footplate Height

4.4.1 To adjust footplate height use the KARMA tool provided to loosen the bolt at the bottom of the footrest arm.

4.4.2 Adjust to required height and re-tighten. (See Figure 4.11)



Figure 4.11



Figure 4.12

 **SUGGESTION:**

- Make sure that the footplate height is adjusted properly according to the user's calf length to reduce pressure on the body.
- The footrest height must be more than 5cm. (See Figure 4.12)

4.5 How to Use the Tipping Lever

4.5.1 Unfold the tipping lever with foot slightly. (See Figure 4.13).

4.5.2 Step the tipping lever downward with foot and hold the both push handles and push them downward by two hands simultaneously to lift the caster to overcome the obstacle. (See Figure 4.14).

4.5.3 The tipping lever can be folded with foot if you do not use it. (See Figure 4.15).



Figure 4.13



Figure 4.14



Figure 4.15

4.6 Footrest Installation and Adjustment

Install footrest :

4.6.1 Loosen screws by using 5mm Allen key which is bundled in the tool box and adjust the length to an appropriate position to fit user's leg-length. (Figure 4-16).

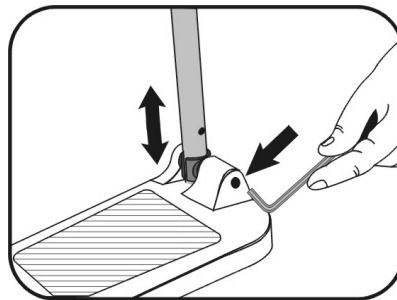

Figure 4.16

4.7 Transporting and Storing

Make sure the wheelchair is folded when it is stored.

SUGGESTION:

- Please store the wheelchair in a location where it is out of direct sunlight, rain, and dew. For more details, consult your KARMA dealer.



WARNING:

- Do not put anything on the wheelchair while it is in storage. Storing goods on a folded wheelchair will cause damage and is not covered by warranty. (See picture right)



WARNING:

- As of this date, SOMA 100 Series(SM-100.5/ SM-150.5) can NOT be used as seats in any vehicles. That is, KARMA recommends that users are NOT transported in any vehicle while seated in the wheelchair. In the case of accident or a sudden stop, the user or passengers may be at risk of getting injury. The suggested solution is to transfer the user from the wheelchair into a vehicle seat and to securely stow the wheelchair in a separate compartment.

4.8 Transferring In

4.8.1 Engage both hand brakes.

4.8.2 Swing the footplates up.

4.8.3 The user lowers himself/ herself into the seat using the armrests for support.

4.8.4 Turn the footplates back down, so that the user can place his feet on them.

Ensure that the heels rest against the heel supports to prevent contact with the casters.

4.8.5 Release both hand brakes.



CAUTION:

- Always ensure that the front casters are in line with the rear wheels and pointing forwards and that the back of the chair is secure either against a wall or firmly held by an attendant.

4.9 Transferring Out

4.9.1 Make sure that the chair is near the place you are transferring to.

4.9.2 Back the chair sufficiently to ensure that the casters are pointing forward, i.e. in line with the rear wheels and usually with the caster forks pointing forward. Ensure that, where possible, the rear of the chair is against a wall or, if not, it must be firmly held by an attendant.

4.9.3 Engage both hand brakes.

4.9.4 Turn the footplates up and swing them to the side.

4.9.5 Slide forwards on the seat.

4.9.6 Place one foot firmly on the ground with the knee at a right angle and the other foot slightly apart and further back.

4.9.7 Place your hands on the front of the armrests and moving your weight forward, bring your head and shoulders up over your knees as you push yourself up.



CAUTION:

- Never stand on the footplates when getting into (or out of) the chair. (See Figure 4.13)
- When getting in and out of the wheelchair please use the hand brakes. The hand brake is the lever at the side of the wheelchair.
- Please ensure that neither the tread on your tires nor the brake block has become too worn. If pneumatic tires are fitted, please maintain at the recommended tire pressure for the same reason.
- Please ensure that occupant's fingers do not get caught in the brake.
- Do not lean on the side panel when transferring in or out.



Figure 4.13



Figure 4.14

When transferring in and out of the chair, make sure that the brakes are applied to prevent the chair from sliding away. Also see that the footplates are flipped up for ease of entering or exiting. (See Figure 4.14)

4.10 Attendant Pushing and Self-propelled

4.10.1 Ensure that the brakes are always locked when the chair is not being pushed. (See Figure 4.15)

4.10.2 Always make sure that both feet are safely on the footplates and that clothing is safely tucked out of the way and cannot get caught in the wheels. (See Figure 4.16)

4.10.3 Always use both hands on the push handles to control the chair. (See Figure 4.17)



Figure 4.15



Figure 4.16



Figure 4.17

4.10.4 Always avoid steep or uneven surfaces because the chair may tip over. (See Figure 4.18)

4.10.5 Always avoid soft surfaces because the casters may get bogged down. (See Figure 4.19)

4.10.6 Always be careful not to go too fast or turn too quickly and try to achieve a smooth steady ride.

4.10.7 Before crossing the tracks, please stop completely and look both ways.

4.10.8 Cross the tracks perpendicular to avoid your wheels getting stuck.

4.10.9 Do not drive at full speed over the railroad tracks.

4.10.10 Be careful going through a doorway that your hands and arms do not get injured.

4.10.11 PLEASE keep in contact with the person in the chair. If you stop to look in shop windows or talk to people, remember to turn the chair so that the person in the chair does not have to turn.

 **WARNING:**

- Never lock the brakes too suddenly as this may tip the user out of the chair.



Figure 4.18



Figure 4.19



Figure 4.20

4.11 Tilting by the Attendant

4.11.1 Make sure both the user's feet are on the footplates and will not slip off. Make sure the handgrips are secure and cannot slip off.

4.11.2 Release both brakes.

4.11.3 Grasp both push handles firmly.

4.11.4 Put your stronger foot on the relevant tipping lever at the back of the chair.

4.11.5 Tell the person in the chair that you are about to tilt the chair backwards.

4.11.6 Pull back with both hands and push down and forwards with the foot. This will bring the chair onto the back wheels. (See Figure 4.20)

CAUTION:

- When a chair is tilted to about 25 degrees it will balance on its rear wheels and be easy to hold. If it is tilted further back it will be difficult to hold and the person in the chair will feel unsafe.
- Lower with a straight back; Keep your foot on the anti-tipper and lower the chair slowly forwards softly to the ground.

4.12 Tilting by the User

4.12.1 Make sure your feet are on the footplates and will not slip off.

4.12.2 Release both brakes.

4.12.3 Grasp both push rims and give a firm, sudden forward push immediately before the obstacle, continue the momentum (be ready to keep pushing) until the obstacle is mounted.

CAUTION:

- This method should only be attempted by people who are experienced in wheelchair use. Strong arms are also necessary. It is always better to have the help of an attendant.
- Leaning backwards causes the casters to rise higher BUT it is much safer to lean forwards and stay balanced.

4.13 Going Down Curbs

Please note: It is always better to avoid curbs where possible by using ramped curbs or slopes and this operation is best attempted with the aid of an attendant.

4.14 Going Down Curbs Forwards With an Attendant

CAUTION:

- This is the more difficult method and can jar the user but allows a better view of traffic.
- Be careful that the anti-tipper does not get caught on the curb causing the user to fall.

NEVER ALLOW THE CHAIR TO TIP FORWARDS WHEN GOING DOWN A CURB.

4.14.1 Position the chair so that the front casters are near the edge of the curb and make sure that the road is clear.

4.14.2 Move the chair slowly and carefully forwards while tilting it back slightly. Be ready to take the weight when the rear wheels cross the curb edge. Ensure that both rear wheels touch the ground at the same time to avoid tipping the chair.

4.14.3 Gently lower the front casters. AVOID JARRING THE USER.

4.15 Going Down Curbs Backwards With an Attendant

CAUTION:

- This is the easier and smoother method BUT it requires the attendant to step backwards into the road.

4.15.1 Back the chair to the curb edge and be careful that the back wheels are equally near the edge.

4.15.2 Grasping the push handles, gently lower the rear wheels onto the road. Be prepared to control the weight as it descends and ensure that the back wheels touch ground at the same time.

4.15.3 Tilt the chair back slightly and pull the tilted chair far enough into the road so that the casters and footrests can be lowered clear of the curb.

4.16 Going Up Curbs

Please note: This operation is best attempted with the aid of an attendant and the best method is to go up curbs forwards as this maintains the direction of travel and is physically less demanding for the attendant.

4.17 Going Up Curbs Forwards With an Attendant

4.17.1 As the footrests nearly touch the curb tilt the chair. The chair should be tilted just high enough to allow the front casters to roll smoothly onto the pavement.

4.17.2 Push the chair forward until the rear wheels are touching the curb. Then, continuing the movement, lift at the push handles while moving the chair forwards.

4.18 Going Up Curbs Backwards With an Attendant

Please note: for safety's sake we do not recommend using this method.

4.19 Up and Down Steps/Stairs

4.19.1 Please note: avoid flights of steps particularly if no extra help is available. 4.20.2 Use ramps or lifts wherever possible.

4.19.2 Two attendants are necessary, each capable of carrying at least half of the combined weight of the person and the wheelchair.

4.19.3 Each helper should bend at the knees and grip the main frame: with the front attendants hands just under the front of the seat, with the back attendant's hands holding the frame just under the push handles.



CAUTION:

- Do not attempt to lift the wheelchair by any removable (detachable) parts. Lifting by means of any removable (detachable) parts of wheelchair may result in injury to the user and/or assistant or damage to the wheelchair.

ALL LIFTING SHOULD BE DONE WITH A STRAIGHT BACK.

Straighten legs to lift the chair. Carefully carry it up or down steps; be aware of how you place your feet - do not cross them and trip yourself up.

5. INSPECTION AND MAINTENANCE

5.1 Daily Check

Check the following items before traveling. If you find anything abnormal, visit your KARMA wheelchair dealer for further inspection before using it.

5.1.1 Examine brakes, checking for wear, damage and misalignment. Replacing or adjusting the brakes should be carried out by your approved repairer.

5.1.2 Check that the hand grips are not damaged and are securely bonded to the push handles.

5.1.3 Check anti-tippers are not damaged and are securely attached.

5.1.4 Check that the anti-tippers' wheels and frame are not damaged and are securely mounted.

5.1.5 Before using the wheelchair, make sure all nuts and bolts are tight. Check all parts for damage or wear and have a qualified technician replace it if necessary. Check all parts for proper adjustment.

5.1.6 Inspect brakes for proper operation.

5.1.7 The wheels and tyres (tires) should be checked periodically for cracks and wear, and should be replaced by a qualified technician.

5.1.8 A qualified technician can be found with an authorized distributor/dealer.



CAUTION:

- Visit a KARMA wheelchair dealer for inspection and maintenance if you find anything abnormal.

5.2 Regular Maintenance Record

In order to ensure that your wheelchair is in good condition, please contact KARMA authorized dealers regularly and make further wheelchair inspection and maintenance records. We recommend that you inspect and maintain your wheelchair **every six months**. A maintenance/service fee may apply.



SUGGESTION:

- Even if you do not use the vehicle for a long time, the wheelchair should still be maintained regularly. You should clean your wheelchair regularly to keep it beautiful and safe.



Item	Weekly	Monthly
GENERAL		
Wheelchair rolls straight (no excessive drag or pull to one side)		V
FRAME AND CROSS BARS		
● Inspect frame structure for small cracks/fissures		V
● Inspect for bent frame or cross bars		V
BRAKES		
● Do not interfere with tyres (tires) when rolling		V
● Pivot points free of wear and looseness		V
● Easy to engage	V	
● Prevent chair from moving when engaged	V	
SEAT & BACKREST		
● Inspect for rips or sagging	V	
● Inspect for loose or broken hardware		V
CASTERS		
● Inspect the casters for smooth rotation of the caster wheel and caster assembly		V
● Inspect the caster for wear in the bearings/mountings and for tyre (tire) wear or damage		V
REAR WHEELS		
● Quick-release axles lock properly; lubricate if necessary	V	
● No excessive side movement or binding when lifted and spun		V
● Inspect for cracked, bent or broken spokes	V	
ARMRESTS		
● Inspect the detachable armrest button for effective locking		V
● Make sure the armrest detaches and flips back properly		V
FOOTRESTS		
● Inspect the footplate height adjustment screws are securely tightened		V
● Inspect the swing-away footrest release lever for effective locking		V

TYRES (TIRES)		
<ul style="list-style-type: none"> ● Inspect for flat spots, cracks and wear ● If pneumatic s, check for proper inflation ● Check tyre (tire) tread depth is more than 1mm ● Check tyre (tire) pressure; tyre (tire) pressures are located on the side of the tyre (tire) 	<p>✓</p> <p>✓</p> <p>✓</p>	<p>✓</p>

 **CAUTION:**

- As with any wheelchair, the wheels and tires should be checked periodically for cracks and wear, and should be replaced. Failure to keep tires at the correct pressure will reduce the braking efficiency.
- Never disassemble or modify the wheelchair frame structure. Otherwise, injury or damage may occur. This will void the warranty.

6. OPTIONA AND ACCESSARIES

	
<ul style="list-style-type: none"> ● Multi-Purpose Safety Belt ● Attaches to all KARMA manual wheelchairs. 	<ul style="list-style-type: none"> ● Backrest Bag ● Standard size. ● Attaches to all KARMA manual wheelchairs.

 **CAUTION:**

- Attaching accessories may alter the overall stability and center-of-gravity of the chair. As such, it should be performed by a qualified repairer and/or a therapist.

7. TROUBLESHOOTING

Trouble or Problems with Your Wheelchair

You can inspect the following before taking your wheelchair to a KARMA wheelchair dealer.

Problem	Checking Points and Corrective Action
1. Chair Veers Right/Left	<ul style="list-style-type: none">● Check tyres (tires) for correct and equal pressure● Check caster bracket angle● Check that rear wheels are equally spaced from the seat frame
2. Sluggish Turn or Performance	<ul style="list-style-type: none">● Check tyres (tires) for correct and equal pressure● Check for loose nuts and bolts
3. Caster Flutter/Wobble	<ul style="list-style-type: none">● Check tyres (tires) for correct and equal pressure● Check for loose nuts and bolts● Check caster bracket angle
4. Squeaks and Rattles	<ul style="list-style-type: none">● Check for loose nuts and bolts
5. Looseness in Chair	<ul style="list-style-type: none">● Check for loose nuts and bolts

If you cannot solve the problem by yourself, contact your KARMA wheelchair dealer for help.

8. SPECIFICATIONS

Product Model	SM-100.5		SM-150.5	
Nominal seat width (mm)	400	450	400	450
Caster x Rear wheel size (in)	7 x 22			
Maximum user weight (kg)	100			
Overall length with legrest (mm)	975	975	975	975
Overall width (mm)	610	665	610	665
Overall height (mm)	875	875	875	875
Folded length (mm)	955	955	955	955
Folded width (mm)	285	285	285	285
Folded height (mm)	875	875	760	760
Total mass (kg)	11.3	11.6	11.4	11.7
Mass of the heaviest part (kg)	11.1	11.4	11.2	11.5
Handrim diameter (mm)	485	485	485	485
Horizontal location of axle (mm)	40	40	40	40
Minimum turning radius (mm)	720	720	720	720
Minimum turning radius without user (mm)	695	695	695	695
Pivot width (mm)	1140	1140	1140	1140
Static stability downhill (X°)	17.2			
Static stability uphill (X°)	11.6			
Static stability uphill with anti-tippers (X°)	N/A			
Static stability sideways (X°)	14.4			
Seat plane angle (X°)	5	5	5	5
Effective seat depth (mm)	480	480	480	480
Nominal seat depth (mm)	440	440	440	440
Effective seat width (mm)	430	480	430	480
Seat surface height at front edge (mm)	480	480	480	480
Backrest angle (X°)	11	11	11	11

Product Model	SM-100.5		SM-150.5	
Seat to backrest angle (X°)	97	97	97	97
Backrest height (mm)	390	390	390	390
Headrest height above seat (mm)	N/A	N/A	N/A	N/A
Leg to seat angle (X°)	96	96	96	96
Footrest to seat distance (mm)	395 ~ 445	395 ~ 445	395 ~ 445	395 ~ 445
Armrest to seat distance (mm)	220	220	220	220
Front location of armrest structure (mm)	335	335	335	335
<p>* The actual product specifications differ from the data in the table by ± 1 cm ± 0.5 kg.</p> <p>* The actual product specifications may vary according to different configurations.</p> <p>* KARMA reserves the right to modify information herein without further notice.</p> <p>* If you want to know more about the measurement methods of wheelchair specifications, please scan the QR code to watch the instructions on the KARMA website.</p>				



Product Model	SM-100.5		SM-150.5	
Nominal seat width (mm)	400	450	400	450
Caster x Rear wheel size (in)	7 x 16			
Maximum user weight (kg)	100			
Overall length with legrest (mm)	920	920	920	920
Overall width (mm)	595	650	595	650
Overall height (mm)	880	880	880	880
Folded length (mm)	940	940	840	840
Folded width (mm)	300	300	300	300
Folded height (mm)	875	875	775	775
Total mass (kg)	10.4	10.7	10.5	10.8
Mass of the heaviest part (kg)	10.2	10.5	10.3	10.6
Handrim diameter (mm)	N/A	N/A	N/A	N/A
Horizontal location of axle (mm)	0	0	0	0
Minimum turning radius (mm)	680	680	680	680

Product Model	SM-100.5		SM-150.5	
Minimum turning radius without user (mm)	665	665	665	665
Pivot width (mm)	1000	1000	1000	1000
Static stability downhill (X°)	N/A			
Static stability uphill (X°)	N/A			
Static stability uphill with anti-tippers (X°)	N/A			
Static stability sideways (X°)	N/A			
Seat plane angle (X°)	7	7	7	7
Effective seat depth (mm)	470	470	470	470
Nominal seat depth (mm)	410	410	410	410
Effective seat width (mm)	420	470	420	470
Seat surface height at front edge (mm)	500	500	500	500
Backrest angle (X°)	13	13	13	13
Seat to backrest angle (X°)	95	95	95	95
Backrest height (mm)	385	385	385	385
Headrest height above seat (mm)	N/A	N/A	N/A	N/A
Leg to seat angle (X°)	95	95	95	95
Footrest to seat distance (mm)	460 ~ 510	460 ~ 510	460 ~ 510	460 ~ 510
Armrest to seat distance (mm)	220	220	220	220
Front location of armrest structure (mm)	330	330	330	330

* The actual product specifications differ from the data in the table by ± 1 cm ± 0.5 kg.

* The actual product specifications may vary according to different configurations.

* KARMA reserves the right to modify information herein without further notice.

* If you want to know more about the measurement methods of wheelchair specifications, please scan the QR code to watch the instructions on the KARMA website.



9. CLEANING & RECYCLING

9.1 Cleaning

In order to lengthen the life of your wheelchair, it is suggested that you clean the wheelchair periodically (if not daily), especially after it is used in the rain or snow. We suggest that you not use your wheelchair in the rain or snow. If you are traveling and get caught in the rain, we suggest you try to find shelter while waiting it out. If you can't find shelter, proceed to your destination.

9.2 Frame

Wipe with a damp cloth.

9.3 Upholstery

9.3.1 When cleaning the upholstery, use warm water and a mild soap.

9.3.2 Upholstery cleaner/foam can also be used, but avoid other cleaning solvents.

9.4 Post-Consumer Recycling

A post-consumer recycling plan should follow the Environmental Protection Administration's regulations. The items listed below are for reference only as local laws and regulations may vary.

Material	Part Name	Method
Aluminum-alloy	Frame	Recyclable
Plastic	Modular Components	Recyclable
Paper	Owner's Manual	Recyclable

9.4.1 There are many organizations in many countries you can find on the Internet that will accept used goods for charity. Please search the information highway to help less fortunate individuals and protect our planet for future generations. If you do not have access to the world wide web please use your local phone directory, ask for operator assistance or go to your local government center for more information. Earth Day is every day.

9.4.2 Check with your local recycling center on where and how to recycle your wheelchair as this information varies from region to region.

10. WARRANTY

10.1 Serial Number

To ensure after-sale service and warranty, please record and fill in the serial number which can be found on the frame.

This warranty is VOID if the original chair serial number is removed or altered.

Model	SM-100.5/ SM-150.5
Serial Number	

10.2 Contents and Duration of Warranty

10.2.1 If the parts of the product need to be repaired or replaced due to manufacturing defects, they can be repaired or replaced free of charge within the warranty period (a repair of this kind will hereafter be called warranty maintenance).

10.2.2 Frame and cross-braces are warranted for a period of 3 years and gas strut for a period of 1 year after delivery to the customer, then the affected parts will be repaired or replaced free of charge.

10.2.3 Consumable parts such as brakes, bearings, footplates, pads, side guards, upholsteries, wheels and similar parts are excluded from the warranty.

10.2.4 Warranty maintenance can be performed by authorized KARMA wheelchair dealers only.

10.2.5 KARMA is not responsible for the transportation costs for repair and replacement.

10.2.6 Warranty maintenance is the repair or replacement according to the condition of the parts, and replaced parts will be the property of KARMA.

10.2.7 KARMA reserves the right to modify product specifications without further notice; KARMA is not responsible for any changes to product specifications.

10.3 The Claims from This Warranty Shall Not Arise for The Following Reasons

10.3.1 The product or part has been damaged by accident, improper use, incorrect assembly or poor maintenance. The evaluation of it is the privilege of KARMA.

10.3.2 Damage resulting from normal wear and tear.

10.3.3 Any overloading of the product, please check the label for maximum user weight.

10.3.4 The product or part has not been maintained or serviced in accordance with the manufacturer' s recommendations as shown in the User Manuals and/or the Service Manuals.

10.3.5 Use or install parts or accessories which are not manufactured or not approved by KARMA.

10.3.6 Damage resulting from use in unsuitable environments.

10.3.7 Damage resulting from any addition, modification, or alteration of the product or parts without the approval by KARMA.

10.3.8 Damage resulting from external factors, such as chemicals, oil, debris, etc.

10.3.9 Damage caused by natural disasters.

10.4 KARMA is Not Responsible for The Following Costs

10.4.1 Replacement or refill of consumable parts, oil or lubricant.

10.4.2 Product inspection, adjustment, lubrication, cleaning, etc.

10.4.3 The costs of regular inspection and maintenance of product.

10.4.4 The product is not repaired by the authorized dealer designated by KARMA.

10.5 The Responsibilities of the User

10.5.1 Fully adhere to operation guidelines set forth in this manual.

10.5.2 Perform self-inspection and basic maintenance.

10.5.3 Keep a record of self-inspections and basic maintenance.

10.5.4 Not permit any alteration, addition, or modification or use of parts not manufactured by KARMA.

10.5.5 Thoroughly read and understand this manual.

10.6 The Responsibilities of the Dealer

10.6.1 Follow this owner's manual and educate user about product operation and basic maintenance

10.6.2 Verify and check whether the warranty conditions are met.

10.6.3 Provide relevant warranty information and recommendations for improvements.

10.7 Transfer of Warranty Rights

If you purchase a second-hand KARMA wheelchair while it is still within the warranty period, bring this user manual and the wheelchair to the authorized dealer and perform necessary product inspection, maintenance and warranty inheritance procedure.

Full name:	
Gender:	
Date of Birth:	
Address:	
Model:	
Serial Number:	
Date of Purchase:	

Dealer's Data

Name of the Store:	
Phone Number and Address:	

If you have any suggestions on how to improve our products, please don't hesitate contacting your local dealer to let us know what you think of your wheelchair. Thank you and enjoy.

soma



KARMA MOBILITY S.L European Support Center.
www.karmamobility.es
+34 984 390 907
karma@karmamobility.es

KARMA MOBILITY LTD. UK representative
www.karmamobility.co.uk
+44 845 630 3436
info@karmamobility.co.uk

KARMA MEDICAL PRODUCTS CO., LTD.
www.KarmaMedical.com
+886 5 206 6688
globalsales@karma.com.tw