

**karma**

*User manual*

*SME*



A Better Wheelchair, A Better Fit

## GENERAL WARNING



### WARNING

Use of this product requires a clinician's diagnosis of suitability with non-obstructed hip joint and stable lower extremities and good bone status.

- DO maintain your chair well, in particular check the tyre (tire) pressure since this affects the efficiency of the brakes.
- DO make sure both brakes are applied before getting in or out of the chair.
- DO make sure both brakes are applied when the chair is not being pushed or used.
- DO take care when climbing kerbs (curbs) or turning on slopes.
- DO avoid steep or uneven surfaces that may cause the chair to tip over.
- DO avoid soft surfaces because the castors (casters) may become bogged down.
- DO travel smoothly in all conditions.
- DO look well ahead to anticipate hazards such as furniture, doors, potholes, etc.
- DO make sure that both feet are safely on the footrests and that clothing is safely tucked out of the way so that it cannot get caught in the wheels.
- DO take care when traveling up or down or across inclines.
- DO keep both hands on the push handles to control the chair, if you are the attendant.
- DO pay attention to keep the chair balanced.
- DO check the frame and components regularly and refer to this user guide during and after the warranty period.
- DO tie-up the upholstery or replace which with a new one when it becomes loose.
- DO lubricate bearings regularly.
- DO equip with anti-tippers to avoid falling backwards.
- DO equip with a seat belt designed for disabled people.
- DO equip with "ankle supports" for disabled people.
- DO clean both hands after oiling the wheelchair.
- DO tighten the screws of headrest tubes.
- DO NOT overload the chair in any circumstance.
- DO NOT hang anything heavy on the back of the chair that could cause the chair to become unstable, particularly when negotiating inclines.
- DO NOT allow more than one user at a time.
- DO NOT use with an unconscious patient.
- DO NOT use other transport to pull the wheelchair.
- DO NOT do "wheelies", as you may fall or tip over backwards and suffer a severe injury.
- DO NOT sit in a wheelchair within a moving vehicle unless it has affixed the labels of hook mark.

- DO NOT go too fast or turn too quickly.
- DO NOT stand on the footplates when getting in or out of the chair.
- DO NOT go down steps forward, whether solo or with an attendant.
- DO NOT attempt to lift the wheelchair by any removable (detachable) parts.
  - Lifting by means of any removable (detachable) parts of the wheelchair may result in injury to the user and/or assistant or damage to the wheelchair.

## **YOU AND YOUR KARMA SERVICE PROVIDER**

- No tools are required for assembly. Your wheelchair should be assembled by your authorized KARMA dealer. Your authorized KARMA dealer is also your service provider. Unauthorized repairs, upgrades and add-ons will negate your warranty. Anything wheelchair related that requires tools should be done by your authorized KARMA service provider. Your KARMA service provider has the necessary service/maintenance manual for your wheelchair.
- If you have any defective parts or lose any parts, please contact your dealer for repair and/or replacement. Please only use parts authorized by KARMA. Use of parts that are not authorized by KARMA will negate your warranty.
- Part numbers are listed on our bill of materials (explosion drawings), which we give to our authorized dealers and service providers. Customers should order parts through their dealer as well as all repairs and scheduled maintenance.
- Customers should go to their dealership for all service needs to guarantee their warranty is not nullified. Always go to an authorized service provider. Unauthorized repairs will nullify your warranty. Procedures other than those described in this user manual must be performed by a qualified technician. They also have the service manual with a complete list of maintenance required to keep your KARMA wheelchair in top performance. Check the Warranty chapter of this user manual to find out what KARMA guarantees and what maintenance and parts you will have to pay for.
- KARMA does not have an official list of service providers at this time. Please contact your dealer for service. If you cannot contact your dealer, please contact another authorized KARMA dealer for service. If all else fails, contact KARMA directly via our website or give us a call and we can refer you to your new service provider.

## CE MARKING

This wheelchair complies with the requirements of the Medical Devices Regulation (EU) 2017/745.



### CAUTION

Before purchasing and using KARMA wheelchairs, please consult qualified professionals so as to ensure that you choose suitable products and use them correctly as well. For safety reasons, to avoid any risk due to the user's movement in the wheelchair or other environmental factors that might cause the wheelchair to tip or the person on the wheelchair to fall off, always use the anti-tippers, pelvic positioning belt, chest belt, and calf strap that are equipped with your wheelchair. You can also purchase other additional safety accessories if needed.

# DECLARATION OF CONFORMITY



Document No.: DOC-EU-SME-02

## EU Declaration of Conformity

We, with the information specified in the below,

### Our information as the manufacturer:

Manufacturer's Name:	KARMA MEDICAL PRODUCTS CO., LTD
Manufacturer's Address:	NO. 2363, Sec. 2, University Rd., Min-Hsiung Shiang, Chia-Yi County, 62144, Taiwan
SRN (Single Registration Number):	TW-MF-000013206

### Our authorized representative:

Name:	KARMA MOBILITY, S.L.
SRN (Single Registration Number):	ES-AR-000004852
Address:	C/ PERIODISTA FRANCISCO CARANTOÑA DUBERT, 23 Bajo 33209 GIJÓN – ASTURIAS, SPAIN
Contact Person:	Raquel Yuste
Contact Information:	(+34) 984 390 907

in accordance with

### Regulation (EU) 2017/745 of the European Parliament and of the council Annex I, II, III, IV and IX

hereby declare that the medical device specified below:

Basic UDI-DI of Annex VI:	471987385SMETU
Device:	Manual wheelchair
Trade Name or Mark:	SME
Model Number:	SME
Product Code according to EMDN:	Y122103, Y122106
Product Code according to GMDN:	46146, 41630
Classification:	Rule 1 of Class I
UDI-DI:	04719873857173

is in conformity with the applicable requirements of the following documents:

Ref. No.	Title	Edition date
ISO 13485	Medical devices - Quality management systems - Requirements for regulatory purposes	2016
ISO 14971	Medical devices - Application of risk management to medical devices	2019
EN 12182	Assistive products for persons with disability - General requirements and test methods	2012
EN 12183	Manual wheelchairs - Requirements and test methods	2014
EN 62366	Medical devices - Application of usability engineering to medical devices	2015
EN ISO 10993-1	Biological evaluation of medical devices - Part 1: Evaluation and testing within a risk management process	2009
EN ISO 10993-5	Biological evaluation of medical devices — Part 5: Tests for in vitro cytotoxicity	2009
EN ISO 15223-1	Medical devices - Symbols to be used with medical device labels, labelling and information to be supplied - Part 1: General requirements	2016
MEDDEV. 2.7/1 Rev. 4	CLINICAL EVALUATION: A GUIDE FOR MANUFACTURERS	2016
MEDDEV 2.12/1 Rev. 8	GUIDELINES ON A MEDICAL DEVICES VIGILANCE SYSTEM	2013

The information on this declaration has been stated on the sole responsibility of KARMA MEDICAL PRODUCTS CO., LTD.

We hereby declare that the device named above has been designed to comply with the relevant sections of the above referenced specifications. The device complies with all General Safety and Performance Requirements.

Date of issue: 21<sup>st</sup> August 2024

Place of issue: NO. 2363, Sec. 2, University Rd., Min-Hsiung Shiang, Chia-Yi County,  
62144, Taiwan

  
CHEN, YING-CHUN CEO



# CONTENTS

<b>1. PREFACE</b> .....	<b>1</b>
<b>2. SAFETY</b> .....	<b>2</b>
2.1 Doorways .....	2
2.2 Leaning.....	2
2.3 Navigating Inclines.....	2
2.4 Kerbs (Curbs).....	2
2.5 Stairs .....	3
2.6 Streets .....	3
2.7 General .....	3
2.8 Upholstery.....	3
2.9 Anti-tippers .....	3
2.10 Maximum User Weight Limit .....	3
2.11 Avoid General Misuse .....	4
2.12 Labeling.....	5
<b>3. INTENDED USE &amp; PARTS</b> .....	<b>6</b>
3.1 Intended Use.....	6
3.2 Parts Description .....	7
<b>4. OPERATION</b> .....	<b>8</b>
4.1 Preparing For Use.....	8
4.2 Adjustments .....	9
4.3 Stand-up Unit .....	15
4.4 Batteries and Charger.....	18
4.5 Transporting and Storing .....	23
4.6 Transferring In and Out.....	24
4.7 General Use .....	26
<b>5. INSPECTION AND MAINTENANCE</b> .....	<b>30</b>
5.1 Daily Check .....	30
5.2 Regular Maintenance Record .....	30
5.3 Batteries, Circuit Breaker and Tyres (Tires) .....	32
5.4 Wiring Precautions After Maintenance .....	33
<b>6. OPTIONS AND ACCESSARIES</b> .....	<b>34</b>
<b>7. TROUBLESHOOTING</b> .....	<b>35</b>
Trouble or Problems with Your Wheelchair .....	35
<b>8. SPECIFICATIONS</b> .....	<b>39</b>
<b>9. CLEANING &amp; RECYCLING</b> .....	<b>41</b>
9.1 Cleaning .....	41
9.2 Post-Consumer Recycling .....	41
<b>10. WARRANTY</b> .....	<b>42</b>
10.1 Serial Number .....	42
10.2 Warranty Policy.....	42

# 1. PREFACE

Please carefully read this user manual before using the wheelchair. Improper use of the wheelchair could result in harm or injury. Therefore, for safe and enjoyable use of the wheelchair, please read this user manual.

- This user manual includes operation instructions for the aspects of the wheelchair, unfolding/folding instructions, and instructions on how to deal with possible accidents.
- This user manual is written for KARMA wheelchair: SME series.
- The symbols used in this user manual are explained below. Pay special attention to the parts marked with these symbols.

 <b>WARNING</b>	Improper use could lead the user to severe injury or death.
 <b>CAUTION</b>	Improper use could lead the user to severe injury and/or damage to your wheelchair.
 <b>NOTE</b>	Follow these instructions to keep the wheelchair in good condition.

- This user manual includes the repair and maintenance chart as well as the warranty.
- If someone else uses the wheelchair, make sure that you give him or her this user manual for his or her reference.
- As designs change, some illustrations and pictures in this user manual may not correspond to the wheelchair that you purchased. We reserve the right to make design modifications without further notice.



## 2. SAFETY

### 2.1 Doorways

The safest way to operate the chair is on level floors that are free of obstacles. Whenever possible use a ramp to enter or exit a facility. Keeping your hands on the push rims will allow you to maintain maximum balance. Do not try to force yourself over an obstruction by propulsion and never use the sides of a doorway to pull yourself through a passageway.

### 2.2 Leaning

- Do not lean over either side of your wheelchair, since such an action may cause you to lose balance and fall. (See Figure 2.1.)
- When sitting on the wheelchair, do not attempt to pick up objects by leaning forward. (See Figure 2.2.)

### 2.3 Navigating Inclines

- Never turn on a hill due to the danger of tipping.
- When assisting, go straight up a slope. If user needs to go down midway, walk backwards until user is on level ground. (See Figure 2.3 and 2.4.)
- Avoid stopping on an incline; it can potentially cause you to lose control of the chair.
- Do not use the brakes to slow down or stop the wheelchair; this could cause it to seize up, causing you to lose control or fall out of the chair.
- Whenever possible, utilize help from an assistant/attendant while navigating inclines.

### 2.4 Kerbs (Curbs)

- Whenever possible get help from an assistant/attendant (if you have assistance make sure that your chair is equipped with push handles).
- Avoid hard impacts when descending a kerb (curb). A hard impact could adversely affect the chair.
- Never try to scale or descend kerbs (curbs) that exceed a normal height. (30–50 mm)
- Always be careful when climbing kerbs (curbs) and never move up or down a kerb (curb) in reverse without an assistant.

## 2.5 Stairs

- Always use two or more assistants.
- Never go down steps forwards.
- Never use an escalator for transport, use an elevator.

## 2.6 Streets

- Always use extreme caution when crossing streets. Reflective tape on the chair and/or your clothing will make you more visible to drivers.
- Avoid potholes and rough terrain that might cause the castors (casters) to become stuck. (See Figure 2.5.)

## 2.7 General

- The expected service life of the product is **five years**, presuming that the product is used daily in accordance with the safety operation instructions, inspection and maintenance instructions, and intended use, which are described in this manual.
- Always make sure BOTH brakes are applied before getting in or out of the chair.
- Never stand on the footplates when getting in or out of the chair.
- Never carry more than one passenger. KARMA wheelchairs are limited to one user.
- Use caution to assure your clothing doesn't get tangled with the wheels.

## 2.8 Upholstery

- When cleaning the upholstery, use warm water and a mild soap.
- Upholstery cleaner/foam can also be used, but avoid other cleaning solvents.

## 2.9 Anti-tippers

Your wheelchair is equipped with anti-tippers. Make sure they have been installed properly. Always use them to avoid personal injury. (See Figure 2.7)

## 2.10 Maximum User Weight Limit

Refer to "Max. User Weight" in "Chapter 8. SPECIFICATIONS" . Loads exceeding maximum capacity can damage your wheelchair and cause malfunctions yielding a safety hazard. The warranty does not cover damage caused by improper operation of the wheelchair.

## 2.11 Avoid General Misuse

- Please note that our "User Manual" contains a number of cautions -- any product can cause injury if misused -- use within our guidelines and with reasonable care and your safety will be increased. Your wheelchair will give years of safe use if used sensibly and carefully. Be aware that careless use endangers your own safety as well as that of others. ALWAYS follow the Highway Code when outdoors and the guidelines written in this user manual.
- Do not let children stand or play on the wheelchair. (See Figure 2.6.)



Figure 2.1



Figure 2.2



Figure 2.3



Figure 2.4



Figure 2.5

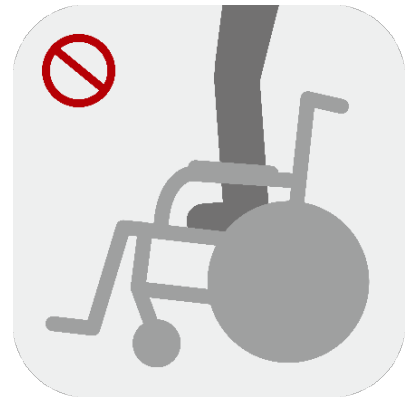

Figure 2.6



Figure 2.7

## 2.12 Labeling

Please carefully read all the labeling on the wheelchair before driving it. Do not remove them. Protect them for future reference.

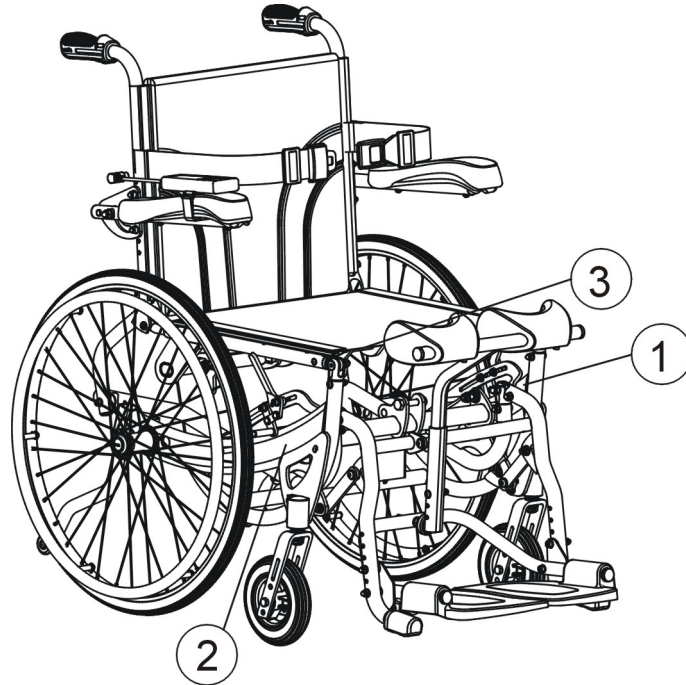

**1**

EC	REP	<b>KARMA MOBILITY, S. L.</b> C/ PERIODISTA FRANCISCO CARANTOÑA DUBERT, 23 Bajo 33209 GUÓN - ASTURIAS (SPAIN)	  
UK	REP	<b>KARMA MOBILITY LTD.</b> UNIT 6 TARGET PARK, SHAWBANK ROAD, REDDITCH, B98 8YN ENGLAND UNITED KINGDOM	
		<b>KARMA MEDICAL PRODUCTS CO., LTD.</b> NO. 2363, SEC. 2, UNIVERSITY RD., MIN-HSIUNG SHIANG, CHIA-YI HSIEN, TAIWAN R.O.C.	
<b>WARNING! USE ONLY ON STABLE SURFACES</b> <b>MAXIMUM USER WEIGHT 120kg (265 lbs)</b>			

**2**

**karma** SERIAL NO. M12-1234

**3**

Model:	
Order No.:	
Delivery Date:	
Sewing No.: <input type="checkbox"/> 1 <input type="checkbox"/> 2 <input type="checkbox"/> 3 <input type="checkbox"/> 4 <input type="checkbox"/> 5 <input type="checkbox"/> 6	
Seat Width	Seat Depth
<input type="checkbox"/> 13	<input type="checkbox"/> 13
<input type="checkbox"/> 14	<input type="checkbox"/> 14
<input type="checkbox"/> 15	<input type="checkbox"/> 15
<input type="checkbox"/> 16	<input type="checkbox"/> 16
<input type="checkbox"/> 17 <input type="checkbox"/> 0	<input type="checkbox"/> 17 <input type="checkbox"/> 0
<input type="checkbox"/> 18 <input type="checkbox"/> 5	<input type="checkbox"/> 18 <input type="checkbox"/> 5
<input type="checkbox"/> 19	<input type="checkbox"/> 19
<input type="checkbox"/> 20	<input type="checkbox"/> 20
<input type="checkbox"/> 21	<input type="checkbox"/> 21
<input type="checkbox"/> 22	<input type="checkbox"/> _____
<input type="checkbox"/> _____	<input type="checkbox"/> _____
<b>karma</b>	Unit: inch

## 3. INTENDED USE & PARTS

### 3.1 Intended Use

- The SME series is a self-propelled or transit wheelchair. That is, it can either be propelled by an attendant (transit) or by the user (self-propelled).
- The wheelchair is suitable for users up to 120 kg in weight. Wheel locks are provided for both rear wheels and are connected to a dual attendant brake located on the left push handle.
- It has an extremely durable aluminum alloy frame with tough accessories and does not suffer in dramatic extremes of temperature (neither user nor attendant need touch metal parts in normal use).
- This chair is designed for both indoor and outdoor use.
- The castors (casters) have solid tyres (tires) for greater durability; pneumatic castors (casters) are available on request.
- When prescribing wheelchairs for use by full or partial amputees (above or below knee, single or double) or other conditions that affect the users natural center of gravity, we suggest contacting your therapist or dealer as well as attaching anti-tippers.
- The stand-up function operates exclusively on a flat surface, away from any stairs, access ramp or slope.

### 3.2 Parts Description

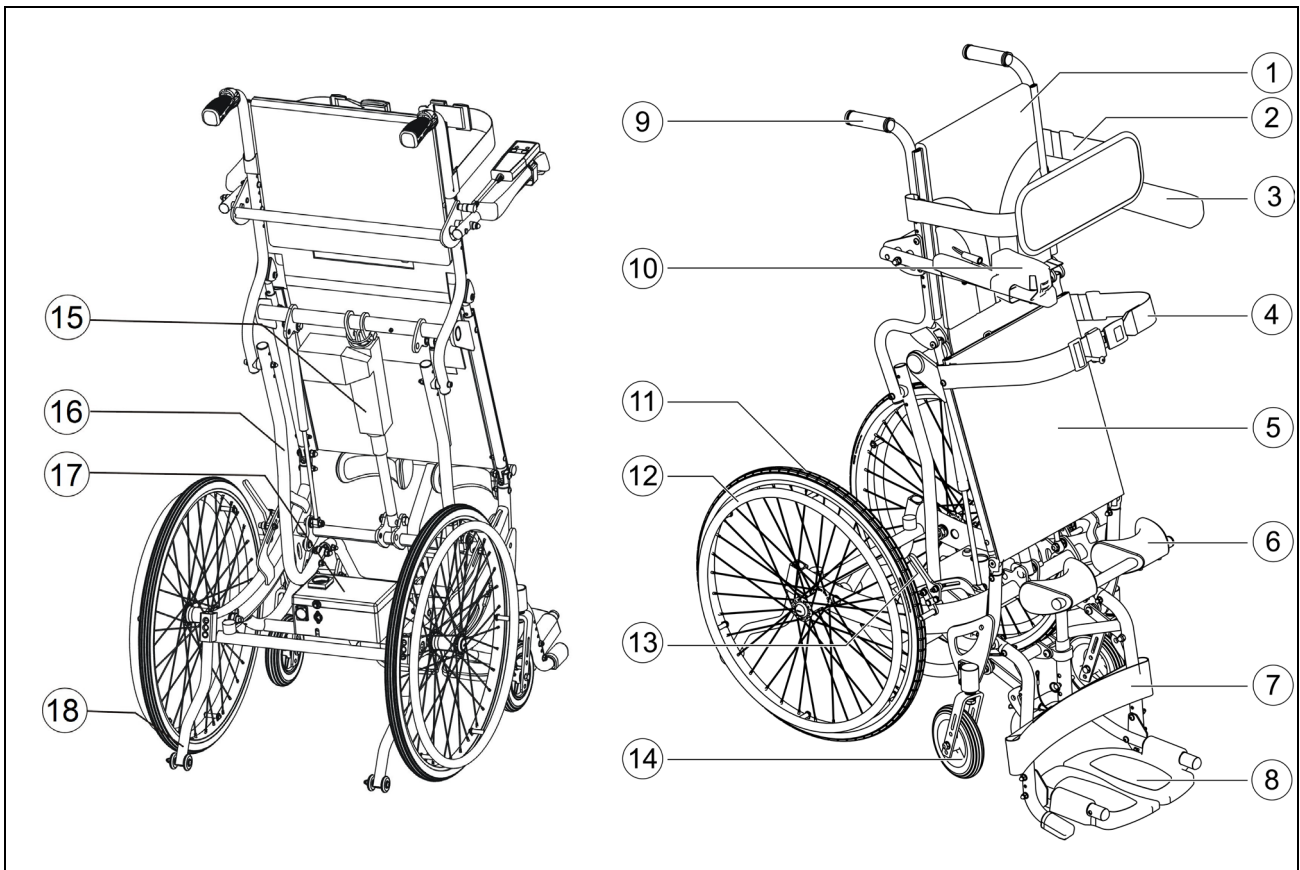

- 1. Backrest Upholstery
- 2. Chest Belt
- 3. Armrest
- 4. Pelvic Positioning Belt
- 5. Seat Upholstery
- 6. Knee Support
- 7. Calf strap
- 8. Footplate
- 9. Push Handle

- 10. Stand-up Control (Handheld Controller)
- 11. Rear Wheel
- 12. Handrim
- 13. Wheel lock
- 14. Front Castor (Front Caster)
- 15. Stand-up Actuator
- 16. Stand-up Strut
- 17. Battery Box
- 18. Anti-tipper

**i NOTE**  
 Available features, specifications, and configurations may vary depending on the country/region where you purchase the product.

## 4. OPERATION

### 4.1 Preparing For Use

4.1.1 Open the box by the top and remove the chair and its components. (See Figure 4.1 and 4.2)

#### 4.1.2 Assembling the rear wheel

- Press the button and pull out the axle from the frame (see Figure 4.3), and then put the axle into the hub.
- First ensure that the brake is in the off position. Take up the assembled wheel and axle and press the button in the center of the axle, as Figure 4.4. This retracts the locking balls that allow you to push the axle into the wheel bracket that is located on the lower rear frame of the wheelchair. When you remove your thumb from the button on the axle, the locking balls should be visible protruding from the axle at the back of the wheel bracket. This will secure the wheel safely in the frame.



Figure 4.1



Figure 4.2



Figure 4.3



Figure 4.4

### 4.1.3 Assembling the backrest

- Straighten up the backrest until the fitting holes of the backrest tube match with the pre-assembled screws on the lower seat tube. (See Figure 4.5 and 4.6.)
- Reassemble the screw as shown in Figure 4.7.

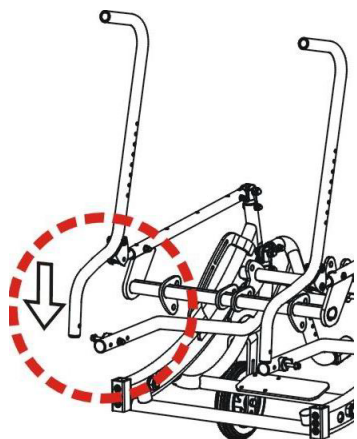

Figure 4.5

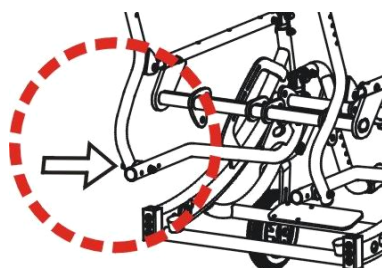

Figure 4.6

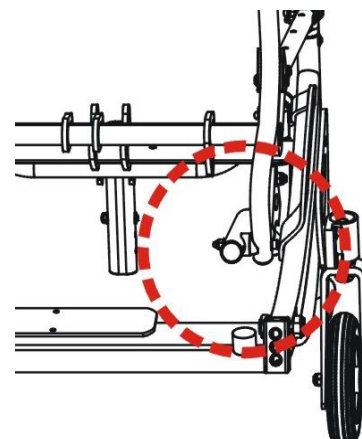

Figure 4.7

## 4.2 Adjustments

### 4.2.1 Seat Depth

To determine the optimum seat depth, specific attention to the user's upper leg length, lower extremity range of motion measures, posture, and flexibility is necessary.

Adjusting the seat depth: loosen and remove the bolts from the seat frame on each side (one bolt from the upper part, and one bolt from the lower part), as shown in the figure below.

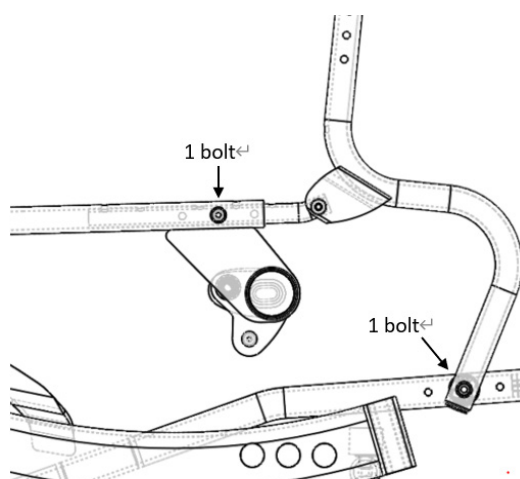



There are 3 levels of seat depth adjustment: 400 mm, 440 mm and 480 mm. The figure below shows the seat depth set-up positions and can be referenced for making adjustments.

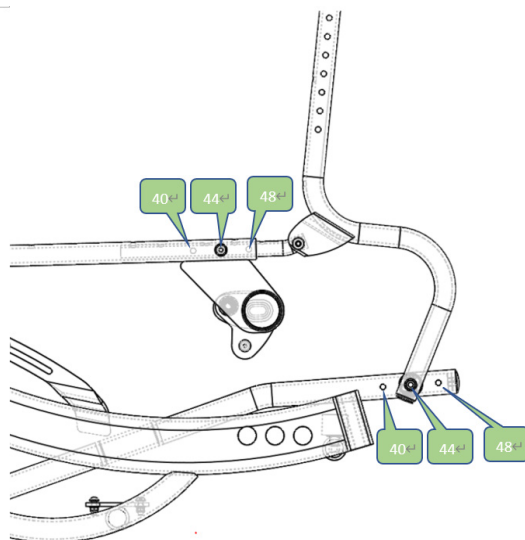

Put the bolts back and tighten them.



#### CAUTION

- Only authorized personnel are allowed to make adjustments.
- Be sure to adjust equally on the left and right sides to prevent the seat frame from getting stuck.
- After seat depth adjustment is completed, confirm the following information:
  - \* The bolts are properly tightened as per the instructions.
  - \* The rear wheel axle is maintained in a proper position and does not affect the stability of the wheelchair. If not, please readjust the rear wheel axle position.



#### NOTE

- The choice of seat depth influences maneuverability and access to motor vehicles.
- Make sure the back of your knees do not touch the seat bottom, as this is bad for your knees and circulation.

## 4.2.2 Footplate

### 4.2.2.1 Removing the footplate

To remove the footplate, press and hold the quick-release button at the front of the frame (❶), and then pull out the footplate (❷), as shown in Figure 4.8.

### 4.2.2.2 Installing the footplate

- To install the footplate, press and hold the quick-release button at the front of the frame (❸) and insert the footplate (❹), as shown in Figure 4.9. Ensure the quick-release button has popped out, indicating the footplate is securely locked into place. Then, flip down the footplate, as shown in Figure 4.10.
- Adjust the footplate height according to the user's calf length by pushing it into position and then tightening the screws. There are four positions available for height adjustment, as shown in Figure 4.11.



### CAUTION

- The screw head should be on the inside, secured from the inside out.
- When transferring into and out of the wheelchair, ensure that the footplates are flipped up. (See Figure 4.12.)
- When adjusting footplate height, be sure user's thigh is safely on the seat upholstery smoothly. And the back of the knee doesn't hit the front edge of seat upholstery. (See Figure 4.13 and 4.14.)
- Adjusting the footrest at the right height means a better pressure relief along the thigh in a seated position.



Figure 4.8



Figure 4.9



Figure 4.10



Figure 4.11



Figure 4.12

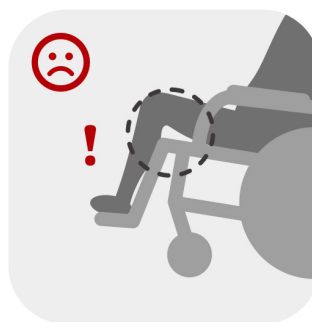

Figure 4.13

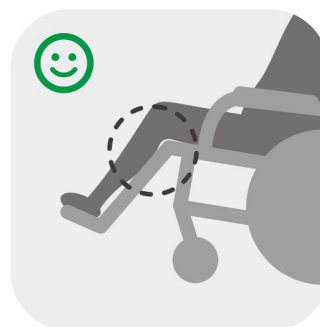

Figure 4.14

### 4.2.3 Flip-back armrest

- A. Height adjustments (5 different height positions): Remove the screws from the armrest fitting tube, adjust to the desired height and put back the screws. Tighten securely. (See Figure 4.15.)
- B. Flipping backwards: To make side transfers easy, the chair is equipped with flip-back armrests. Just flip the armrest backwards. (See Figure 4.16.)



Figure 4.15

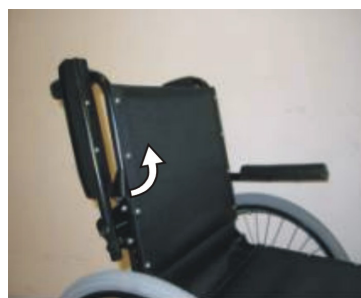

Figure 4.16



#### CAUTION

**When transferring in/out, pay attention to the following:**

- There is a risk of structural damage or breakage if the armrest is subjected to high lateral pressure. Please be particularly cautious when using it.
- It is recommended to use transfer aids (such as a transfer board) or mobility aids (such as a walker).
- When transferring in/transferring out, always lower the seat to its lowest position to maintain a sitting posture.

If you have further questions about transferring, please consult your therapist for professional advice.

## 4.2.4 Knee Support

Before standing, it is important to adjust the knee support in depth and height and to adjust the U-formed knee-supports in the angle and width.

Adjustment in the depth:

Screw or unscrew the adjusting bolt until you have reached the desired depth. Keep 30 to 40 mm between the knee of the end-user and the knee-support. (See Figure 4.17.)

- A. Adjustment in height (3 different heights possible): To adjust, remove bolt, slide knee support to desired height and put the bolt back. Tighten securely. The upper edge of the knee support has to be below the patella. (See Figure 4.18.)
- B. Angle adjustment: Loosen the fitting screws from the knee-supports and proceed with angle adjustment according to the morphology of the user. (See Figure 4.19.) Once adjusted, tighten up the screws securely.
- C. Adjustment in the width: Loosen up the fitting screws from the knee-supports and proceed with width adjustment right and left within the tube limits. (See Figure 4.20.) Once adjusted, tighten up the screws securely.



### CAUTION

These adjustments will have to be optimized after a progressive standing session. This will enable to avoid exaggerated pressure on the knees and to guarantee a good alignment of the limbs.

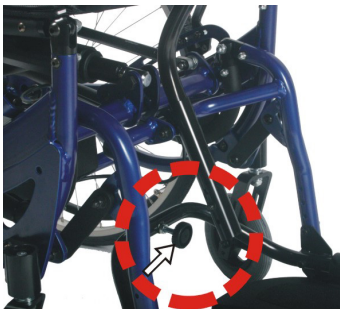

Figure 4.17

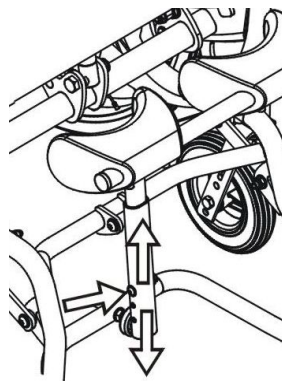

Figure 4.18



Figure 4.19



Figure 4.20



Figure 4.21

## 4.2.5 Backrest Upholstery

When the backrest upholstery is loose, you can tighten it by pulling and re-attaching the Velcro. (See Figure 4.21.)

## 4.2.6 Chest strap height

The chest strap can be fitted at two different height between the upholstery fastening strip and backrest tube.

To adjust height, remove the screw, put the chest strap to the desired height and put the screw back. Tighten securely. (See Figure 4.22.)

Secure the trunk with chest strap and safety buckle. The chest strap is adjustable according to the morphology of the end user. (See Figure 4.23.)



Figure 4.22



Figure 4.23



Figure 4.24



### WARNING

- Make sure that the chest strap does not get caught in the spokes when it release.
- This chest strap is not to be used as a safety belt in a vehicle.
- The chest strap should be fitted below the armpit and should not loop the arm over trunk in order to avoid the hazard causing by the trunk slipping down. (See Figure 4.24.)

## 4.3 Stand-up Unit

### 4.3.1 Wiring Diagram

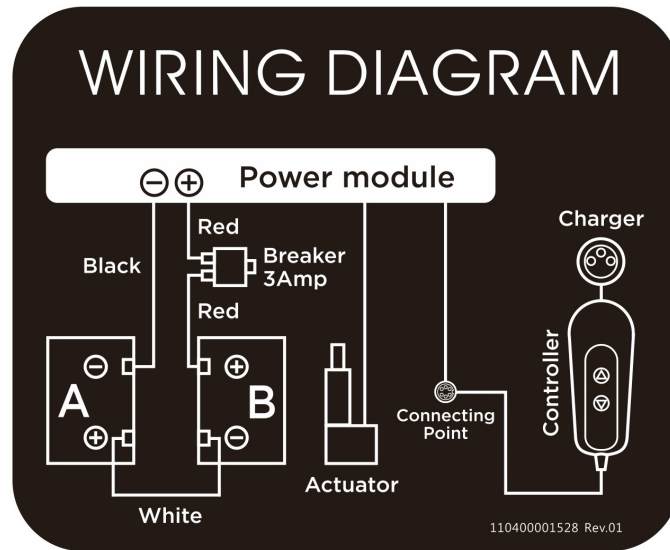

### 4.3.2 Stand-up Function

1. Secure the wheelchair with the wheel locks and turn on the power switch.
2. Press the "Seat standing button"  $\triangle$  and hold it for more than 0.5 seconds to raise the seat to a standing position.
3. Press the "Seat return button"  $\nabla$  and hold it for more than 0.5 seconds to lower the seat back to a sitting position.
4. Turn off the power switch.
5. Release the wheel locks to use the wheelchair.



#### CAUTION

If you press the "Seat return button" ( $\nabla$ ) and then quickly press the "Seat standing button" ( $\triangle$ ), a delay will occur. This is a normal design feature to protect the motor from burning out.

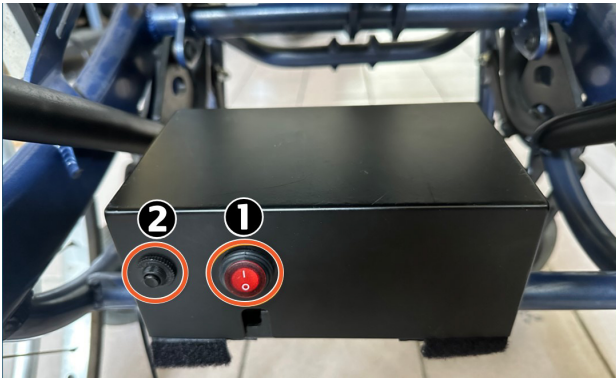

1. Power switch
2. Circuit breaker

3. Seat standing button  $\triangle$
4. Seat return button  $\nabla$

### CAUTION

- When using the stand-up function of the wheelchair, the user should fasten the chest belt, use the knee support, and engage the wheel locks to avoid the risk of falling. Additionally, ensure that the user's limbs or clothing are not placed under the seat or behind the backrest to prevent injury from the moving parts.
- When using the stand-up function without an occupant, make sure to fasten the chest belt and pelvic positioning belt, and place them on the seat or backrest to avoid contact with the wheelchair's moving parts. Failure to follow these instructions may cause the chest belt and pelvic positioning belt to get stuck in the wheelchair mechanism, resulting in damage.
- The stand-up function of the wheelchair should only be used on flat surfaces to avoid the risk of falling.
- When not using the stand-up function, press the power switch to turn off the power to prevent battery drain or accidental activation.

### NOTE

Apply regular machine oil to lubricate the moving parts of the seat standing and backrest reclining mechanisms once or twice a month. If the usage is frequent or abnormal noises occur, increase the lubrication frequency as needed.

### 4.3.3 Instructions of Emergency Descending Switch

Please refer to the figure below. One yellow Emergency Descending Switch is equipped under the left (or the right) armrest. In the case of a controller failure causing the seat cannot be lowered to the seating position, press this Emergency Descending Switch to activate the actuator to lower the seat. It prevents the user from standing for a long period of time should the controller is faulty.





## 4.4 Batteries and Charger

Use the supplied charger to charge your wheelchair. Please pull back the silicone cover of the handheld controller, insert the round plug of the charger into the charger socket of the handheld controller, and charging will begin.

### NOTE

For further information about the charger (such as the definition/behavior of the charger indicator light), refer to the user manual that comes with the charger itself and select the correct charging voltage.

### CAUTION

- Be aware that the handheld controller will not function while charging.
- Standby for one day is equivalent to use the battery power for 15 times.



Connect the charger to the charger socket of the handheld controller.

1. Charger socket of the handheld controller
2. Charger

### 4.4.1 Battery box

The battery box holds two batteries (2 × 2.9 Ah).

### 4.4.2 Battery cleaning

If the battery is contaminated by dirty water, battery acid, or other dust, it will discharge quickly. Therefore, please follow the steps below to clean the battery:

1. Turn off the power.
2. Use a clean cloth to wipe the wheelchair frame around the battery box.
3. Use a clean cloth to wipe the battery. If there is white powder on the terminals, stop using the wheelchair as this may indicate battery acid leakage, and contact customer service.
4. When the battery is low, the controller will emit a “beep” sound.

### 4.4.3 Battery Replacement/Installation

1. For new battery installations, obtain the battery cable (as indicated by the arrow below) from the inside of the switch on the power module housing.

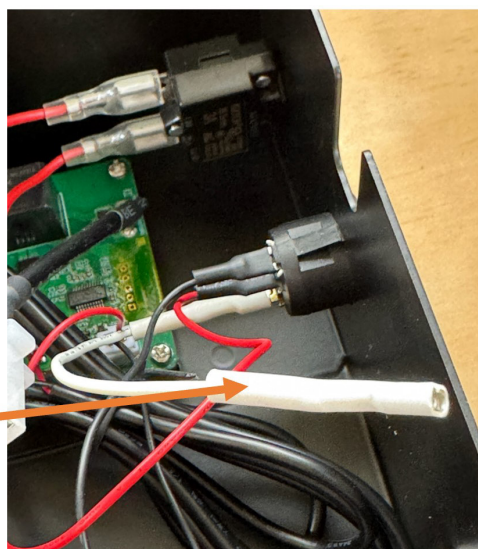
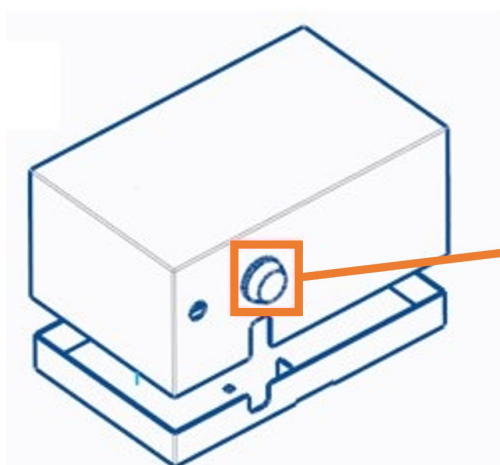

2. If the battery needs to be replaced or installed, please follow the figure below to connect the battery.

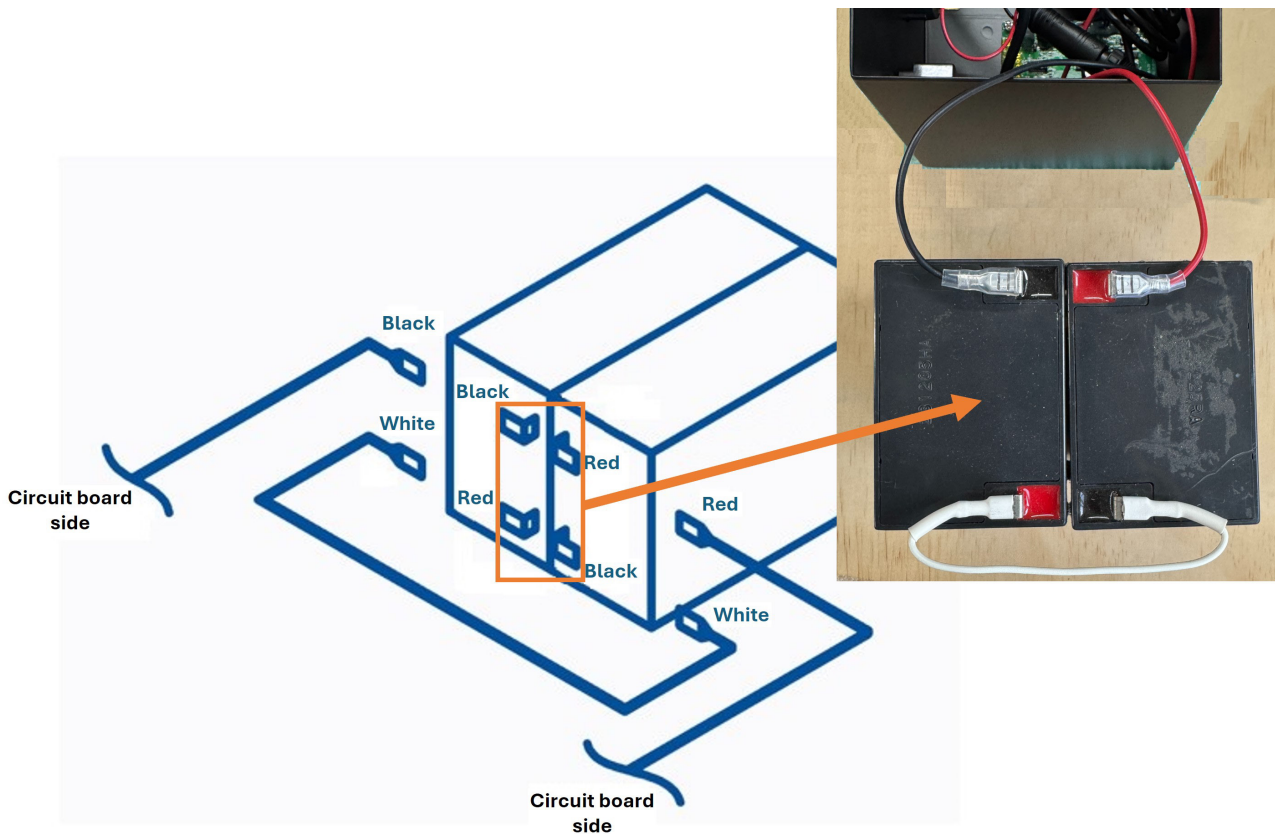

 CAUTION

- The batteries weigh approximately 1.2 kg each (2 batteries). Ensure you have enough strength to handle them during installation or removal.
- This wheelchair uses maintenance-free batteries that do not require replacement or refilling of battery fluid.
- The batteries provided with this wheelchair are sealed and maintenance-free. To avoid damage or danger, do not open the battery box. When storing the wheelchair or charging, do not place the batteries in environments below  $-10^{\circ}\text{C}$  or above  $50^{\circ}\text{C}$ , as such conditions will reduce battery life or cause overheating and damage.
- Keep the wheelchair and batteries away from fire sources, such as cigarettes or stoves.

#### 4.4.4 Charger

1. You can determine whether the battery is charging or fully charged by the indicator light on the charger. For detailed information about the indicator light, refer to the user manual that comes with the charger itself.
2. Follow the instructions in the charger's user manual for operating the charger.
3. This charger is a smart charger suitable for various lead-acid batteries.



#### NOTE

When charging, a maximum of 3 hours is sufficient. This ensures the battery is fully charged. After charging is completed, remember to unplug the connected plug.

#### 4.4.5 Charging steps

The charger socket of the wheelchair is located at the front of the handheld controller. Please pull back the silicone cover of the handheld controller and follow the instructions below to complete the charging process.

1. Turn on the power switch.
2. Pull back the silicone cover of the handheld controller and check that the charger socket is not blocked.
3. Insert the round plug of the charger into the charger socket.
4. Insert the main power plug of the charger into the electrical outlet. The entire charging process takes about 3 hours.
5. Determine if charging is completed by the indicator light on the charger. For detailed information about the indicator light, refer to the user manual that comes with the charger itself.
6. Remove the round plug from the charger socket of the handheld controller.

#### 4.4.6 When to charge

1. Charge the batteries when the handheld controller's battery indicator shows red.
2. To maintain battery performance, it is recommended to fully charge the batteries after each use.
3. If not used for a long period, charge the batteries once a week to ensure they remains fully charged.
4. The battery box holds two batteries (2 × 2.9 Ah). When fully charged, new batteries can provide approximately 120 cycles of the standing function (sit → stand → sit).

#### 4.4.7 Charging Tips

1. It is recommended to make charging a daily routine. At least fully charge the batteries 3 to 4 times a week.
2. If the batteries take more than 3 hours to charge and does not reach a fully charged state, the charger may be faulty or the batteries may be aging. If this occurs, do not attempt to repair them yourself as it can be dangerous. Contact the supplier or customer service immediately and replace the batteries promptly to avoid harm to the user or the wheelchair.



#### WARNING

- Using the batteries without fully charging them will reduce its lifespan.
- Do not use extension cords or multi-socket outlets for charging.
- If the above battery maintenance conditions are not followed or incorrect replacements are made, KARMA will not be responsible for any resulting product malfunctions or hazards.



#### NOTE

- Do not expose the charger to outdoor heat sources such as radiators, fire, or direct sunlight.
- Do not move the wheelchair before removing the round plug of the battery charger from the wheelchair and the main power plug from the electrical outlet. The power switch on the controller does not need to be turned on while charging.
- Determine if charging is completed by the indicator light on the charger. For detailed information about the indicator light, refer to the user manual that comes with the charger itself. Do not stop charging before it is fully charged.
- Once charging is completed, unplug the charger. However, to avoid overcharging, do not exceed a maximum charging time of 3 hours.
- Charging time is related to external temperature. Longer charging times are needed in winter.
- Please follow the rules below to avoid danger while charging:
  1. Use the standard charger provided by KARMA. Non-standard chargers can cause danger. Unauthorized modifications to the charging circuit are prohibited. KARMA is not responsible for any accidents caused by such

**i** NOTE

modifications.

2. Do not disassemble or modify the charger.
3. Ensure good ventilation during charging. Do not charge in direct sunlight or humid environments.
4. Do not cover the charger with any waterproof cloth or items while charging.
5. The charger casing may become slightly warm during operation. This is normal.
6. The charger is not waterproof.
7. Do not place the charger on top of flammable items such as fuel, footrests, or seats while charging.
8. Lead-acid batteries do not have a memory effect. Keeping the battery fully charged helps extend its lifespan. Frequent deep discharges (below half the remaining charge) will shorten the battery's lifespan.

## 4.5 Transporting and Storing

**i** NOTE

Please store the wheelchair in a location where it is out of direct sunlight, rain and dew. For more details, consult your KARMA dealer.

**!** CAUTION

Don't put anything on the wheelchair while it is in storage. Storing goods on a folded wheelchair will cause damage and is not covered under warranty. (See the figure on the right.)





## WARNING

As of this date, SME can NOT be used as seats in any vehicles. That is, KARMA recommends that users are NOT transported in any vehicle while seated in the wheelchair. In the case of accident or a sudden stop, the user or passengers may be at risk of getting injury. The suggested solution is to transfer the user from the wheelchair into a vehicle seat and to securely stow the wheelchair in a separate compartment.

## 4.6 Transferring In and Out

### 4.6.1 Transferring In

1. Turn off the power of the controller.
2. Engage both wheel locks.
3. Remove the knee supports and flip up the footplates.
4. For users transferring from the front, once the back of the calves touch the front edge of the seat upholstery, slowly bend forward and sit down.
5. Flip down the footplates, so that the user can place his/her feet on them.
6. Insert the knee supports, and fasten the pelvic positioning belt and chest belt.
7. To use the standing function, turn on the power of the controller. To propel, release the wheel locks.



## CAUTION

Always ensure that the front castors (casters) are in line with the rear wheels and pointing forwards and that the back of the chair is secure either against a wall or firmly held by an attendant.

### 4.6.2 Transferring Out

1. Make sure that the chair is near your final destination.
2. Back the chair sufficiently to ensure that the castors (casters) are pointing forward, i.e. in line with the rear wheels and usually with the castor (caster) forks pointing forward. Ensure that, where possible, the rear of the chair is against a wall or, if not, it must be firmly held by an attendant.
3. Engage both wheel locks to secure the chair.
4. Turn off the power of the controller.
5. Remove the knee supports and flip up the footplates.
6. Unfasten the chest belt and pelvic positioning belt.
7. For users transferring from the front, move your hips forward, bring your feet

back as much as possible and place them on the floor, then slowly bend forward to stand up.

8. Move to your final destination.

 **CAUTION**

- Never stand on the footplates when getting into (or out of) the chair. (See Figure 4.25.)
- When getting in and out of the wheelchair, please engage the wheel locks. The wheel lock is the lever at the side of the wheelchair.
- Do not sit in or get up from the wheelchair on slopes, unstable surfaces, uneven terrain, or in dangerous environments.
- Please ensure that neither the tread on your tyres (tires) nor the brake block has become too worn. If pneumatic tyres (tires) are fitted, please maintain at the recommended tyre (tire) pressure for the same reason.
- Please ensure that occupant's fingers do not get caught in the brake.

**When transferring in/out, pay attention to the following:**

- There is a risk of structural damage or breakage if the armrest is subjected to high lateral pressure. Please be particularly cautious when using it.
- It is recommended to use transfer aids (such as a transfer board) or mobility aids (such as a walker).
- When transferring in/transferring out, always lower the seat to its lowest position to maintain a sitting posture.

If you have further questions about transferring, please consult your therapist for professional advice.

When transferring in and out of the chair, make sure that the brakes are applied to prevent the chair from sliding away. Also see that the footplates are flipped up for ease of entering or exiting. (See Figure 4.26.)



Figure 4.25



Figure 4.26



## 4.7 General Use

### 4.7.1 Attendant Pushing and Self-propelled

Do ensure that the brakes are always locked when the chair is not being pushed. (See Figure 4.27.)

Always make sure that both feet are safely on the footplates and that clothing is safely tucked out of the way and cannot get caught in the wheels. (See Figure 4.28.)

Always use both hands on the push handles to control the chair. (See Figure 4.29.)

Always avoid steep or uneven surfaces because the chair may tip over. (See Figure 4.30.)

Always avoid soft surfaces because the castors (casters) may get bogged down. (See Figure 4.31.)

Always be careful not to go too fast or turn too quickly and try to achieve a smooth steady ride.

Before crossing the tracks, please stop completely and look both ways.

Cross the tracks perpendicular to avoid your wheels getting stuck.

Do not drive at full speed over railroad tracks.

Be careful going through a doorway that your hands and arms do not get injured.

PLEASE keep in contact with the person in the chair. If you stop to look in shop windows or talk to people, remember to turn the chair so that the person in the chair does not have to turn.

#### **WARNING**

NEVER lock the brakes too suddenly as this may tip the user out of the chair.



Figure 4.27



Figure 4.28

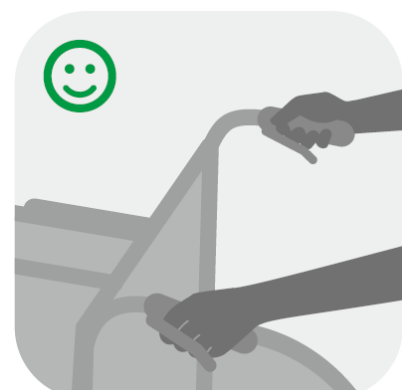

Figure 4.29



Figure 4.30



Figure 4.31



Figure 4.32

### 4.7.2 Tilting by the Attendant

Make sure both the user's feet are on the footplates and will not slip off. Make sure the handgrips are secure and cannot slip off.

Release both brakes.

Grasp both push handles firmly.

Put your stronger foot on the relevant tipping lever at the back of the chair.

Tell the person in the chair that you are about to tilt the chair backwards.

Pull back with both hands and push down and forwards with the foot. This will bring the chair onto the back wheels. (See Figure 4.32.)

#### CAUTION

When a chair is tilted to about 25 degrees it will balance on its rear wheels and be easy to hold. If it is tilted further back it will be difficult to hold and the person in the chair will feel unsafe.

Lower with a straight back; keep your foot on the anti-tipper and lower the chair slowly forwards softly to the ground.

### 4.7.3 Tilting by the User

Make sure your feet are on the footplates and will not slip off.

Release both brakes.

Grasp both push rims and give a firm, sudden forward push immediately before the obstacle, continue the momentum (be ready to keep pushing) until the obstacle is mounted.

#### CAUTION

This method should only be attempted by people experienced in wheelchair use.



## CAUTION

Strong arms are also necessary. It is always better to have the help of an attendant. Leaning backwards causes the castors (casters) to rise higher BUT it is much safer to lean forwards and stay balanced.

### 4.7.4 Going Down Kerbs (Curbs)

Please note: It is always better to avoid kerbs (curbs) where possible by using ramped kerbs (curbs) or slopes and this operation is best attempted with the aid of an attendant.

#### 4.7.4.1 Going Down Kerbs (Curbs) Forwards with and Attendant



## CAUTION

This is the more difficult method and can jar the user but allows a better view of traffic.

Be careful that the anti-tipper does not get caught on the kerb (curb) causing the user to fall.

**NEVER ALLOW THE CHAIR TO TIP FORWARDS WHEN GOING DOWN A KERB (CURB).**

Position the chair so that the front castors (casters) are near the edge of the kerb (curb) and make sure that the road is clear.

Move the chair slowly and carefully forwards while tilting it back slightly. Be ready to take the weight when the rear wheels cross the kerb (curb) edge. Ensure that both rear wheels touch the ground at the same time to avoid tipping the chair.

Gently lower the front castors (casters). **AVOID JARRING THE USER.**

#### 4.7.4.2 Going Down Kerbs (Curbs) Backwards with an Attendant



## CAUTION

This is the easier and smoother method BUT it requires the attendant to step backwards into the road.

Back the chair to the kerb (curb) edge and be careful that the back wheels are equally near the edge.

Grasping the push handles, gently lower the rear wheels onto the road. Be

prepared to control the weight as it descends and ensure that the back wheels touch ground at the same time.

Tilt the chair back slightly and pull the tilted chair far enough into the road so that the castors (casters) and footrests can be lowered clear of the kerb (curb).

#### 4.7.5 Going Up Kerb (Curbs)

Please note: This operation is best attempted with the aid of an attendant and the best method is to go up kerb (curbs) forwards as this maintains the direction of travel and is physically less demanding for the attendant.

##### 4.7.5.1 Going Up Kerb (Curbs) Forwards with an Attendant

As the footrests nearly touch the kerb (curb) tilt the chair. The chair should be tilted just high enough to allow the front castors (casters) to roll smoothly onto the pavement.

Push the chair forward until the rear wheels are touching the kerb (curb). Then, continuing the movement, lift at the push handles while moving the chair forwards.

##### 4.7.5.2 Going Up Kerbs (Curbs) Backwards with an Attendant

Please note: for safety's sake we do not recommend using this method.

#### 4.7.6 Up and Down Steps/Stairs

Please note: avoid flights of steps particularly if no extra help is available. Use ramps or lifts wherever possible.

Two attendants are necessary, each capable of carrying at least half of the combined weight of the person and the wheelchair.

Each helper should bend at the knees and grip the main frame: with the front attendants hands just under the front of the seat, with the back attendants' hands holding the frame just under the push handles.



#### CAUTION

Don't attempt to lift the wheelchair by any removable (detachable) parts. Lifting by means of any removable (detachable) parts of wheelchair may result in injury to the user and/or assistant or damage to the wheelchair.

#### **ALL LIFTING SHOULD BE DONE WITH A STRAIGHT BACK.**

Straighten legs to lift the chair. Carefully carry it up or down steps; be aware of how you place your feet -- do not cross them and trip yourself up.

## 5. INSPECTION AND MAINTENANCE

### 5.1 Daily Check

Check the following items before traveling. If you find anything abnormal, visit your KARMA wheelchair dealer for further inspection before using it.

Examine brakes, checking for wear, damage and misalignment. Replacing or adjusting the brakes should be carried out by your approved repairer.

Check that the hand grips are not damaged and are securely bonded to the push handles.

Check anti-tippers are not damaged and are securely attached.

Check that the anti-tippers' wheels and frame are not damaged and are securely mounted.

Check that the headrest screws are tightened.

Before using the wheelchair, make sure all nuts and bolts are tight. Check all parts for damage or wear and have a qualified technician replace it if necessary. Check all parts for proper adjustment.

Inspect brakes for proper operation.

The wheels and tyres (tires) should be checked periodically for cracks and wear, and should be replaced by a qualified technician.

A qualified technician can be found with an authorized distributor/dealer.



#### CAUTION

Visit a KARMA wheelchair dealer for inspection and maintenance if you find anything abnormal.

### 5.2 Regular Maintenance Record

In order to ensure that your wheelchair is in good condition, please contact KARMA authorized dealers regularly and make further wheelchair inspection and maintenance records. We recommend that you inspect and maintain your wheelchair **every six months**.

A maintenance/service fee may apply.



#### NOTE

Even if you don't use the wheelchair for a long time, the wheelchair should still be maintained regularly. You should clean your wheelchair regularly to keep it in good condition and safe.

Item	Weekly	Monthly
<b>GENERAL</b>		
● Wheelchair rolls straight (no excessive drag or pull to one side)		✓
<b>FRAME AND CROSS BARS</b>		
● Inspect frame structure for small cracks/fissures		✓
● Inspect for bent frame or cross bars		✓
<b>BRAKES</b>		
● Do not interfere with tyres (tires) when rolling		✓
● Pivot points free of wear and looseness		✓
● Easy to engage	✓	
● Prevent chair from moving when engaged	✓	
<b>HEADREST, SEAT &amp; BACKREST</b>		
● Inspect for rips or sagging	✓	
● Inspect for loose or broken hardware		✓
<b>CASTORS (CASTERS)</b>		
● Inspect the castors (casters) for smooth rotation of the castor (caster) wheel and castor (caster) assembly		✓
● Inspect the castor (caster) for wear in the bearings/mountings and for tyre (tire) wear or damage		✓
<b>REAR WHEELS</b>		
● Quick-release axles lock properly; lubricate if necessary	✓	
● No excessive side movement or binding when lifted and spun		✓
● Inspect for cracked, bent or broken spokes	✓	
<b>ARMRESTS</b>		
● Inspect the detachable armrest button for effective locking		✓
● Make sure the armrest detaches and flips back properly		✓
<b>FOOTRESTS</b>		
● Inspect the footplate height adjustment screws are securely tightened		✓
● Inspect the swing-away footrest release lever for effective locking		✓
<b>TYRES (TIRES)</b>		
● Inspect for flat spots, cracks and wear	✓	
● If pneumatic tyres (tires), check for proper inflation	✓	
● Check tyre (tire) tread depth is more than 1mm		✓
● Check tyre (tire) pressure; tyre (tire) pressures are located on the side of the tyre (tire)	✓	



## CAUTION

If you find anything abnormal, stop using the wheelchair immediately and visit a KARMA wheelchair dealer for inspection and maintenance.

As with any wheelchair, the wheels and tyres (tires) should be checked periodically for cracks and wear, and should be replaced. Failure to keep tyres (tires) at the correct pressure will reduce the braking efficiency.



## CAUTION

Never disassemble or modify the wheelchair frame structure. Otherwise, injury or damage may occur. This will negate the warranty.

### **5.3 Batteries, Circuit Breaker and Tyres (Tires)**

5.3.1 Battery: Ensure the battery is regularly charged. We recommend not letting the battery completely discharge to avoid reducing its lifespan. Refer to Section “4.4 Batteries and Charger” for detailed information about the battery.

5.3.2 Circuit Breaker: The circuit breaker is located on the power module’s housing, which can prevent mechanical damage caused by excessive current load during use. The circuit breaker will trip to cut off the power circuit when necessary. If there is a power outage, check if the circuit breaker has returned to its normal state.

5.3.3 Tyre (Tires): The maintenance-free tyre (tires) do not require inflation or maintenance, but please check the tyre (tires) wear condition regularly (once a month). If the tread depth is less than 1 mm or there are cracks, contact KARMA to replace the tyre (tires). Under normal conditions, the lifespan of maintenance-free tyre (tires) is comparable to that of pneumatic tires.

## 5.4 Wiring Precautions After Maintenance

When replacing the battery or actuator, if the wiring harness has been untied, please pay attention to the following wiring precautions:

1. Ensure that the wires do not enter hazardous cutting areas.
2. Secure the tie points according to the figure below.
3. The wiring path must follow the figure below exactly.

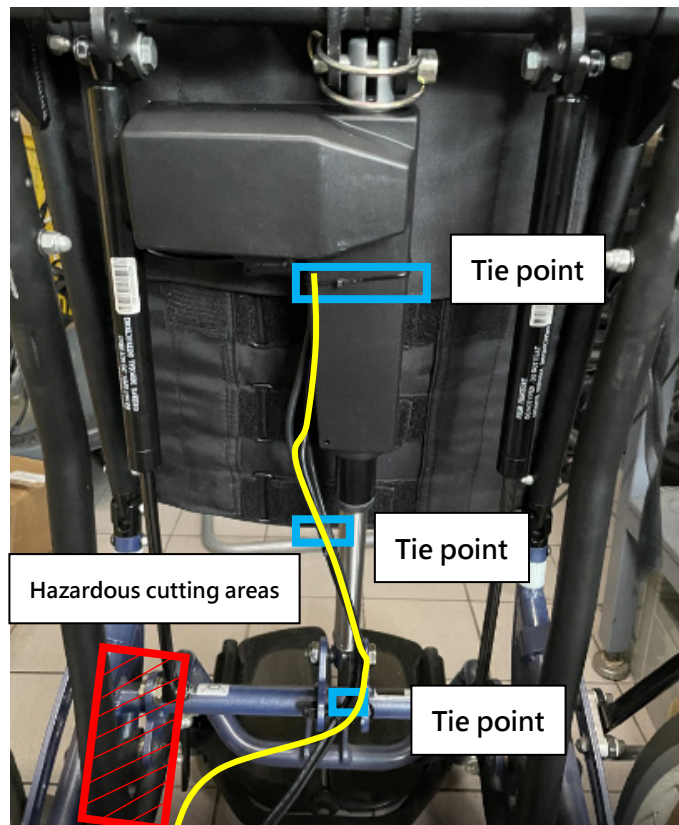



## 6. OPTIONS AND ACCESSORIES

	
<p>■ Backrest Bag</p> <ul style="list-style-type: none"><li>• Standard size.</li></ul>	<p>■ Harness</p>



### CAUTION





Attaching accessories may alter the overall stability and center-of-gravity of the chair. Thus, this should be performed by your approved repairer and therapist.





## 7. TROUBLESHOOTING

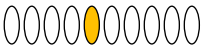

### Trouble or Problems with Your Wheelchair

You can inspect the following before taking your wheelchair to a KARMA wheelchair dealer.

Problem	Checking Points and Corrective Action
Wheelchair Veers Right/Left	<ul style="list-style-type: none"> <li>● Check tyres (tires) for correct and equal pressure</li> <li>● Check castor (caster) bracket angle</li> <li>● Check that rear wheels are equally spaced from the seat frame</li> </ul>
Sluggish Turn or Performance	<ul style="list-style-type: none"> <li>● Check tyres (tires) for correct and equal pressure</li> <li>● Check for loose nuts and bolts</li> </ul>
Castor (Caster) Flutter/Wobble	<ul style="list-style-type: none"> <li>● Check tyres (tires) for correct and equal pressure</li> <li>● Check for loose nuts and bolts</li> <li>● Check castor (caster) bracket angle</li> </ul>
Squeaks and Rattles	Check for loose nuts and bolts
Looseness in Wheelchair	Check for loose nuts and bolts
Wheelchair does not stand-up	<ul style="list-style-type: none"> <li>● Are the batteries charged?</li> <li>● Does the battery indicator show enough power?</li> <li>● Has the circuit breaker tripped?</li> </ul>
The handheld controller does not respond	<ul style="list-style-type: none"> <li>● Please check if the controller shows any indicator light.               <ul style="list-style-type: none"> <li>&gt; If not, press either <math>\triangle</math> or <math>\nabla</math> to check if it is in standby mode.</li> <li>&gt; If still no response, check if the wiring is broken.</li> <li>&gt; If the controller shows an indicator light, proceed to the next step:</li> </ul> </li> <li>● Check for any error codes. If there are any, press and hold <math>\triangle</math> or <math>\nabla</math> for more than 3 seconds to exit the error code mode.</li> </ul>

Problem	Checking Points and Corrective Action
<p>The first light on the handheld controller is on.</p> 	<p>This indicates an abnormal battery status, primarily due to low battery power.</p> <ul style="list-style-type: none"> <li>● Check if the wheelchair is overloaded. The maximum user weight limit is 120 kg. Remove the load and restart to see if it works.</li> <li>● Check if there are any mechanical parts that are not moving smoothly during use. If so, try lubricating those parts.</li> <li>● Try to charge the batteries. If it still does not work, it means the battery is no longer usable. Contact customer service to replace the battery.</li> </ul>
<p>The second light on the handheld controller is on.</p> 	<p>This indicates a poor battery health status, primarily due to overcharging and excessive discharging.</p> <ul style="list-style-type: none"> <li>● You can try to charge the batteries to recover it.</li> <li>● If it still does not work, it means the battery is no longer usable. Contact customer service to replace the battery.</li> </ul>
<p>The third light on the handheld controller is on.</p> 	<p>This indicates a charger error, primarily due to using a charger that does not meet the specifications.</p> <ul style="list-style-type: none"> <li>● Please ensure you are using the original KARMA charger.</li> <li>● Check if the connector is properly connected to the charger.</li> </ul> <p>Verify the indicator light on the charger and refer to Section “4.4.4 Charger” of this user manual, as well as the instructions provided with the charger itself.</p>
<p>The fourth light on the handheld controller is on.</p> 	<p>This indicates an emergency descending switch failure, primarily due to a detected abnormality (disconnection) in the switch wiring.</p> <ul style="list-style-type: none"> <li>● Please check if the wiring is loose or broken.</li> <li>● Contact customer service.</li> </ul>

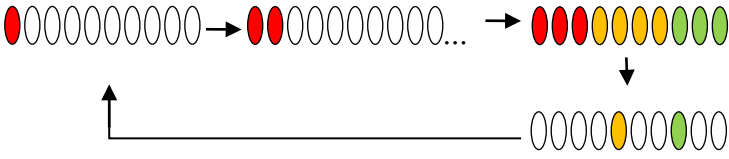
Problem	Checking Points and Corrective Action
<p>The fifth light on the handheld controller is on.</p> 	<p>This indicates a controller error.</p> <ul style="list-style-type: none"> <li>● Please check if the battery is low and if the device can be restarted.</li> <li>● Check if there are any abnormalities or breaks in the wiring.</li> <li>● Verify if the circuit breaker is functioning properly.</li> </ul>
<p>The sixth light on the handheld controller is on.</p> 	<p>This indicates an abnormal signal from the battery box MCU.</p> <ul style="list-style-type: none"> <li>● Please restart the device to check if the signal is still abnormal.</li> <li>● Check if there are any abnormalities or breaks in the wiring.</li> </ul>
<p>The seventh light on the handheld controller is on.</p> 	<p>This indicates an actuator lift malfunction.</p> <ul style="list-style-type: none"> <li>● Please check if the actuator has any external damage.</li> <li>● Check if there are any exposed or short-circuited wires.</li> </ul>
<p>The eighth light on the handheld controller is on.</p> 	<p>This indicates that the actuator detected an overcurrent limit during operation, causing the motor to stop running.</p> <ul style="list-style-type: none"> <li>● Check if the wheelchair is overloaded. The maximum user weight limit is 120 kg. Remove the load and restart to see if it works.</li> <li>● Verify if the circuit breaker has tripped.</li> </ul>
<p>Multiple indicator lights flashing.</p> 	<p>This indicates that the fifth and eighth lights are flashing. As mentioned above, the error status is due to overloading and a controller malfunction. Refer to the previously mentioned troubleshooting instructions for detailed solutions.</p>

Problem	Checking Points and Corrective Action
<p>Error code displayed during charging.</p>	<ol style="list-style-type: none"> <li data-bbox="619 253 1441 459"> <p>1. Fully Charged Status</p> <p>When fully charged, the indicator will show all lights (10 lights) for 3 seconds, followed by the error code flashing for 3 seconds.</p>  </li> <li data-bbox="619 589 1441 936"> <p>2. Charging status</p> <p>The lights will cycle once (from 0 lights to 10 lights), followed by the error code flashing for 3 seconds.</p>  </li> </ol>
<p>Unable to use without any apparent reason</p>	<ol style="list-style-type: none"> <li data-bbox="619 992 1441 1093"> <p>1. Restart the power switch: Press down to the "O" position first, then press back to the "I" position.</p> </li> <li data-bbox="619 1104 1441 1205"> <p>2. Observe the indicator lights on the controller to see if it restarts.</p>  </li> <li data-bbox="619 1267 1441 1312"> <p>3. Check if the operation can move up and down.</p> </li> <li data-bbox="619 1323 1441 1426"> <p>4. If there is still no response, contact customer service.</p> </li> </ol>

If you cannot solve the problem by yourself, contact your KARMA wheelchair dealer for help.

## 8. SPECIFICATIONS

Product Model	SME		
Nominal seat width (mm) <sup>1</sup>	400	440	480
Nominal seat depth (mm) <sup>2</sup>	400	440	480
Front caster/Rear wheel size (in)	6/24	6/24	6/24
Backrest height (mm)	415	415	415
Headrest height above seat (mm)	N/A	N/A	N/A
Armrest to seat distance (mm)	160–240	160–240	160–240
Front location of armrest structure (mm)	0–310	0–310	0–310
Seat surface height at front edge (mm)	490	490	490
Footrest to seat distance (mm)	350–410	350–410	350–410
Effective seat width (mm)	400	440	480
Effective seat depth (mm)	455	485	515
Seat plane angle (X°)	1	1	1
Backrest angle (X°)	10	10	10
Seat to backrest angle (X°)	99	99	99
Leg to seat angle (X°)	92	92	92
Overall length with legrest (mm)	1005–1060	1005–1060	1005–1060
Overall width (mm)	590	630	670
Overall height (mm)	950	950	950
Folded length (mm)	1015	1015	1015
Folded width (mm)	535	580	625
Folded height (mm)	600	600	600
Total mass (kg)	27.4	29.8	32.0
Mass of the heaviest part (kg)	18.8	21.0	23.2
Maximum user weight (kg)	120	120	120
Minimum turning radius (mm)	790	790	790
Minimum turning radius without user (mm)	750	750	750

Product Model	SME		
Pivot width (mm)	1130	1130	1130
Static stability downhill (X°)	8	8	8
Static stability uphill (X°)	10.1 (with anti-tippers)	10.1 (with anti-tippers)	10.1 (with anti-tippers)
Static stability sideways (X°)	18	18	18
Handrim diameter (mm)	525	525	525
Horizontal location of axle (mm)	40–100	40–100	40–100
Battery capacity (Ah)	2.9*2	2.9*2	2.9*2
Charger output current (A)	1	1	1

1. **Nominal seat width** is measured the width of seat cushion at 120 mm in front of the backrest. This value is mainly used in the product ordering process.

2. **Nominal seat depth** is measured from the front end of the seat cushion to the back cushion. This value is mainly used in the product ordering process.

- The actual product specifications differ from the data in the table by  $\pm 10$  mm  $\pm 0.5$  kg.

- The actual product specifications may vary according to different configurations.

- KARMA reserves the right to modify information herein without further notice.

- Please scan the **QR code** to watch more instructions of the measurement methods on the KARMA website.



## 9. CLEANING & RECYCLING

### 9.1 Cleaning

In order to lengthen the life of your wheelchair, it is suggested that you clean the wheelchair periodically (if not daily), especially after it is used in the rain or snow. We suggest that you don't use your wheelchair in the rain or snow. If you are traveling and get caught in the rain, we suggest you try to find shelter while waiting it out. If you can't find shelter, proceed to your destination.

#### 9.1.1 Frame

Wipe with a damp cloth.

#### 9.1.2 Upholstery

When cleaning the upholstery, use warm water and a mild soap.

Upholstery cleaner/foam can also be used, but avoid other cleaning solvents.

### 9.2 Post-Consumer Recycling

A post-consumer recycling plan should follow the Environmental Protection Administration's regulations. The items listed below are for reference only as local laws and regulations may vary.

Material	Part Name	Method
Aluminum-alloy	Frame	Recyclable
Plastic	Modular Components	Recyclable
Paper	User Manual	Recyclable

There are many organizations in many countries you can find on the Internet that will accept used goods for charity. Please search the information highway to help less fortunate individuals and protect our planet for future generations. If you do not have access to the world wide web please use your local phone directory, ask for operator assistance or go to your local government center for more information. Earth Day is every day.

Check with your local recycling center on where and how to recycle your wheelchair as this information varies from region to region.



## 10. WARRANTY

### 10.1 Serial Number

To ensure after-sale service and warranty, please record and fill in the serial number which can be found on the frame.

This warranty is VOID if the original chair serial number is removed or altered.

Model	SME
Serial Number	

### 10.2 Warranty Policy

#### 10.2.1 Contents and Duration of Warranty

- If the parts of the product need to be repaired or replaced due to manufacturing defects, they can be repaired or replaced free of charge within the warranty period (a repair of this kind will hereafter be called warranty maintenance).
- Frame and cross-braces are warranted for a period of 5 years and gas strut for a period of 1 year after delivery to the customer, then the affected parts will be repaired or replaced free of charge.
- Consumable parts such as brakes, bearings, footplates, pads, side guards, upholsteries, wheels and similar parts are excluded from the warranty.
- Warranty maintenance can be performed by authorized KARMA wheelchair dealers only.
- KARMA is not responsible for the transportation costs for repair and replacement.
- Warranty maintenance is the repair or replacement according to the condition of the parts, and replaced parts will be the property of KARMA.
- KARMA reserves the right to modify product specifications without further notice; KARMA is not responsible for any changes to product specifications.

#### 10.2.2 The Claims from This Warranty Shall Not Arise for the Following Reasons

- The product or part has been damaged by accident, improper use, incorrect assembly or poor maintenance. The evaluation of it is the privilege of KARMA.
- Damage resulting from normal wear and tear.
- Any overloading of the product, please check the label for maximum user weight.
- The product or part has not been maintained or serviced in accordance with the manufacturer's recommendations as shown in the User Manuals and/or the Service Manuals.
- Use or install parts or accessories which are not manufactured or not

approved by KARMA.

- Damage resulting from use in unsuitable environments.
- Damage resulting from any addition, modification, or alteration of the product or parts without the approval by KARMA.
- Damage resulting from external factors, such as chemicals, oil, debris, etc.
- Damage caused by natural disasters.

### **10.2.3 KARMA is Not Responsible for The Following Costs**

- Replacement or refill of consumable parts, oil or lubricant.
- Product inspection, adjustment, lubrication, cleaning, etc.
- The costs of regular inspection and maintenance of product.
- The product is not repaired by the authorized dealer designated by KARMA.

### **10.2.4 Responsibilities**

#### **10.2.4.1 The Responsibilities of the User**

- Fully adhere to operation guidelines set forth in this manual.
- Perform self-inspection and basic maintenance.
- Keep a record of self-inspections and basic maintenance.
- Not permit any alteration, addition, or modification or use of parts not manufactured by KARMA.
- Thoroughly read and understand this manual.

#### **10.2.4.2 The Responsibilities of the Dealer**

- Follow this manual and educate users about product operation and basic maintenance.
- Verify and check whether the warranty conditions are met.
- Provide relevant warranty information and recommendations for improvements.

## 10.2.5 Transfer of Warranty Rights

If you purchase a second-hand KARMA wheelchair while it is still within the warranty period, bring this user manual and the wheelchair to the authorized dealer and perform necessary product inspection, maintenance and warranty inheritance procedure.

Full name:	
Gender:	
Date of Birth:	
Address:	
Model:	
Serial Number:	
Date of Purchase:	

### Dealer' s Data

Name of store:	
Telephone and Address:	

If you have any suggestions on how to improve our products, please don't hesitate contacting us know what you think of your wheelchair. Thank you and enjoy.

# karma

A Better Wheelchair, A Better Fit



KARMA MOBILITY S.L European Support Center  
[www.karmamobility.es](http://www.karmamobility.es)  
+34 984 390 907  
[karma@karmamobility.es](mailto:karma@karmamobility.es)

KARMA MOBILITY LTD. UK representative  
[www.karmamobility.co.uk](http://www.karmamobility.co.uk)  
+44 845 630 3436  
[info@karmamobility.co.uk](mailto:info@karmamobility.co.uk)

KARMA MEDICAL PRODUCTS CO., LTD.  
[www.KarmaMedical.com](http://www.KarmaMedical.com)  
+886 5 206 6688  
[globalsales@karma.com.tw](mailto:globalsales@karma.com.tw)